





Voster ATS Team
is a professional cycling
group racing with the UCI
Continental Team license. The team consists
of ten riders belonging to the leading Polish road
cyclists, bronze medalist of the Polish championship
- Paweł Franczak or the best mountaineer of Tour de
Pologne - Patryk Stosz. The team competes in
road races throughout Poland and Europe,
representing the colours of the Voster
company everywhere.

TABLE OF CONTENTS

INTERIOR DOOR WINGS

FRAMED DOOR WINGS

NON-REBATED FRAMED DOOR WINGS

■ LOFT	14-15
■ MEDIOLAN NEW	16-17
■ MOBI	18-19
■ BERGAMO	20-21
■ GRAFO	22-23
■ RUMBA	24-27

COLORS COLLECTION

■ RUMBA	28-31
---------	-------

REBATED FRAMED DOOR WINGS

■ RUMBA	34-35
■ DUO	36-37
■ VINCI	38-39
■ BELLO	40-41
■ MOBI	42-43
■ KUBUS, LUPUS	44-45
■ INCANTO	46-47
■ PRADO	48-49
■ MURANO	50-51
■ NEUTRA	52-53
■ MEDIOLAN	54-55
■ BORNOS	56-57
■ BERGAMO	58-59
■ MARS	60-61
■ VICAR	62-63
■ TIGA	64-65
■ TANGO	66-67
■ LUGO	68-69
■ TOLEDO	70-71
■ LATINO	72-73
■ BRANDY	74-75
■ ROCCO	76-77
■ ZITRON	78-79
■ VANILLA	80-81
■ ETNA	82-83
■ ANTARES	84-85
■ PRIX	86-87

PLATINIUM COLLECTION

■ MODEL Q	90-91
■ MODEL X	92-93
■ MODEL Y	94-95
■ MODEL V	96-97

GLASS DOOR WINGS

■ MONO	98-99
■ WINDOOR II, WINDOOR IV, WINDOOR SPAGHETTI	100-101
■ PLATO	102-103

PLAIN DOOR WINGS **NEW**

■ NON-REBATED	108-109
■ NON-REBATED TO SARA PRO SYSTEM	110-111
■ DOOR FRAME, SARA PRO HIDDEN SYSTEM	112-113
■ MODERNO NON-REBATED NEW	114-115
■ MAGNETIC NON-REBATED NEW	116-117
■ PLAIN PANEL REBATED DOOR WINGS NEW	118-119

VARNISHED DOOR WINGS

■ PLAIN	120
■ KORA, METRIX, SOFIA, MILANO, ALBA	121

SLIDING SYSTEMS

■ SINGLE FRAMELESS CASSETTE	122-123
■ ALUMINIUM SLIDING SYSTEM G/K SINGLE	124
■ DOOR FRAMES TO SINGLE ALUMINIUM SLIDING SYSTEM G/K	125
■ DOUBLE ALUMINIUM SLIDING SYSTEM G/K	126
■ DOOR FRAMES TO DOUBLE ALUMINIUM SLIDING SYSTEM G/K	127
■ ON-WALL SLIDING SYSTEM SINGLE	128-129
■ ON-WALL SLIDING SYSTEM DOUBLE	130-131
■ SYSTEM LOFT GLASS NEW	132-133
■ LOFT LINE SYSTEM	134-135
■ ALUMINIUM ON-WALL SLIDING SYSTEM	136-137
■ SLIDING SYSTEM MAGPLUS NEW	138-139

DOOR FRAMES

■ NON-REBATED ADJUSTABLE DOOR FRAME V-RETTO	140
■ NON-REBATED FIXED DOOR FRAME NEW	141
■ REBATED ADJUSTABLE DOOR FRAME V-RETTO STANDARD	142-143
■ ADJUSTABLE DOOR FRAME STANDARD	144-145
■ CASING FRAME	146
■ FIXED DOOR FRAME	147
■ TOP LIGHT TO ADJUSTABLE V-RETTO DOOR FRAME	148
■ TOP LIGHT TO ADJUSTABLE STANDARD DOOR FRAME NEW	149

AKCESORIA

■ OPENWORK NEW , MASKING BAND 100 ADJ. NEW , PROTECTIVE PANEL NEW , FLOOR MOULDING TRIMS, DECORATIVE LAMELLAS NEW , PLATINIUM DOOR HANDLES, DOOR HANDLES, HINGE CASINGS, VENTILATION SLEEVES, CYLINDERS, DOOR CLOSER, SLIDING SYSTEM SYNCH, SEALS, MASKING BANDS, QUARTER ROUNDS, ELECTRIC STRIKE	150-160
---	---------

TECHNICAL INFORMATION

161-171

LOFT
non-rebated
door wing,
page 14-15



TYPES OS VENEER

PLATINIUM



Platinum: Foil of polypropylene finishing. Resistant to water, steam, stains, scratches and abrasion. Easy to clean, resistant to chemical exposure, flexible. Exceptional printing quality, unique match of embossing and printing, render of natural wooden structures.

CPL



CPL: high resistance to: abrasion, scratches, sunlight. Wooden structure.

white matt



grey

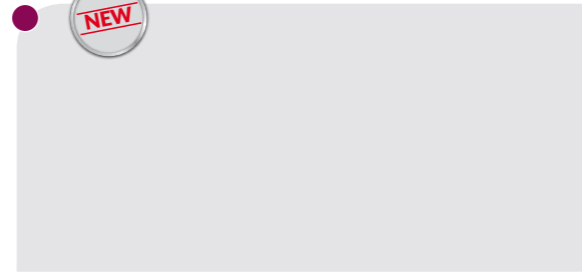

white CPL*

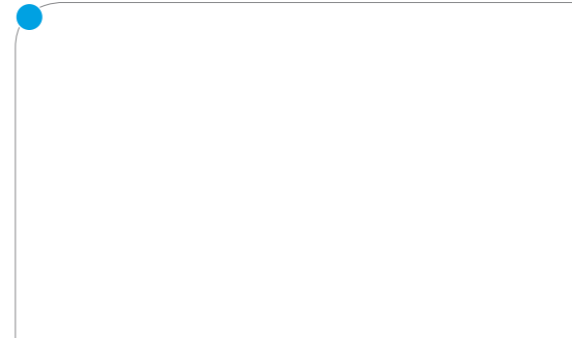

acacia CPL



bianco

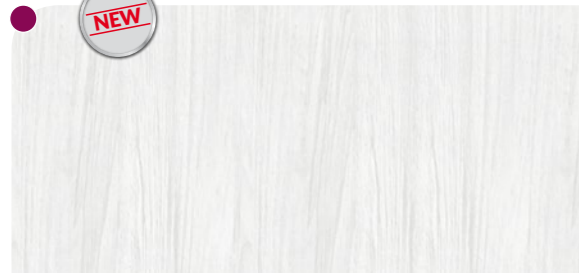

oak arctic



polar oak CPL



ash CPL

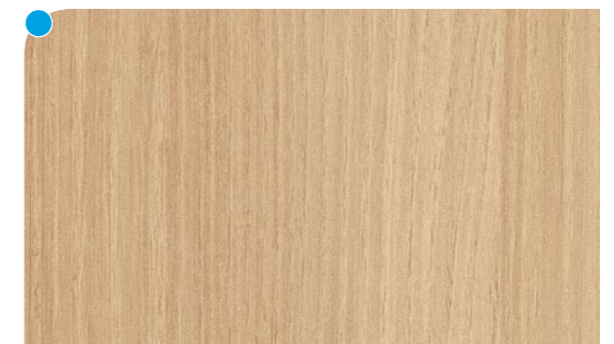

oak latte



oak Bawaria



sand oak CPL



oak CPL

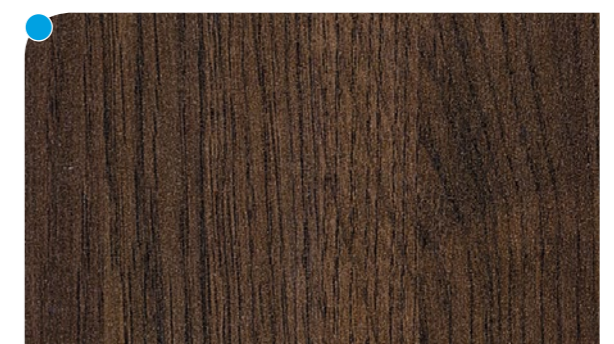

copper

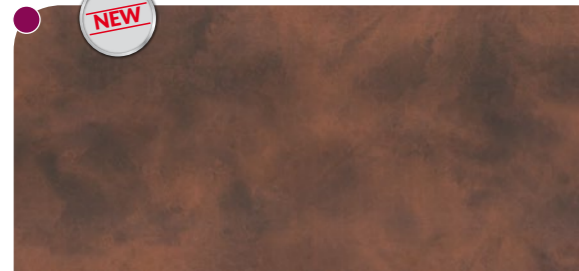

marengo



oak carbon



black matt



* decors available while stocks last

TYPES OS VENEER

3D

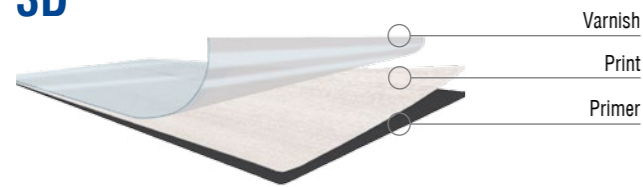

3D Veneer: three-dimension effect. Unique imitation of wooden structure and form. Resistance to abrasion.

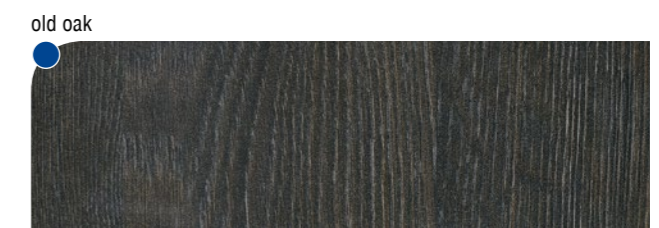
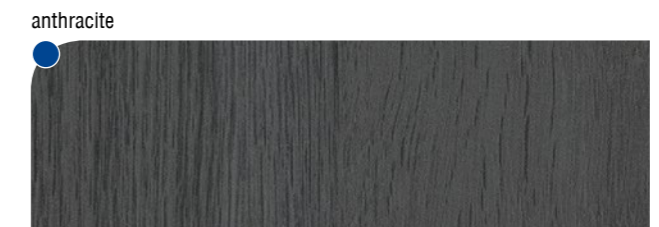
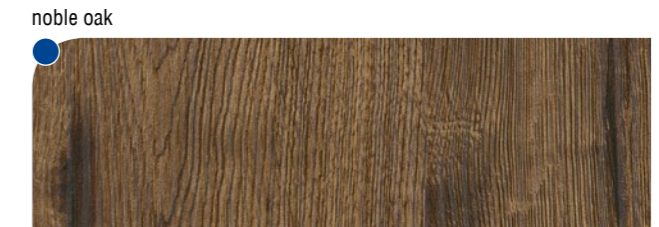
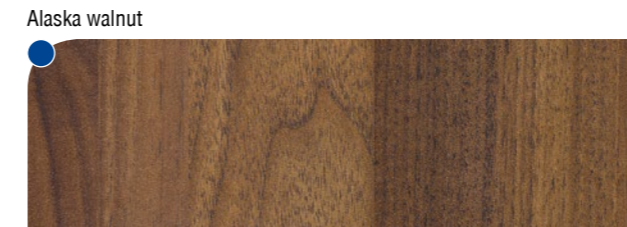
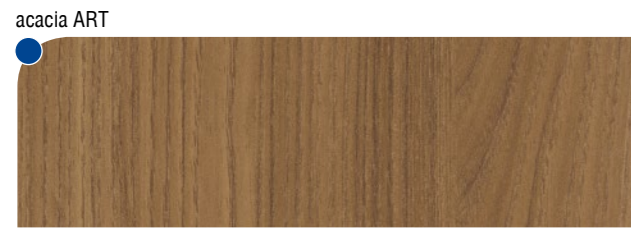
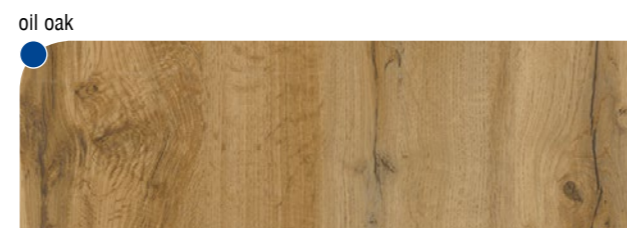
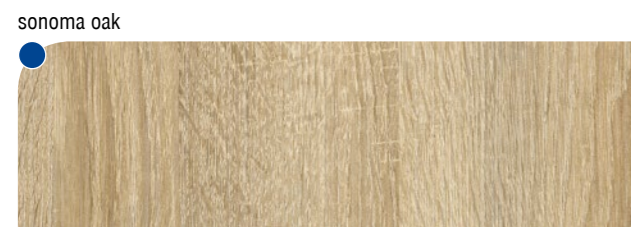
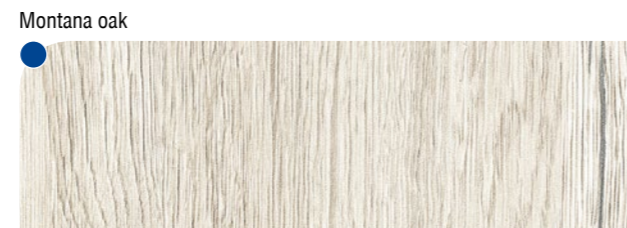
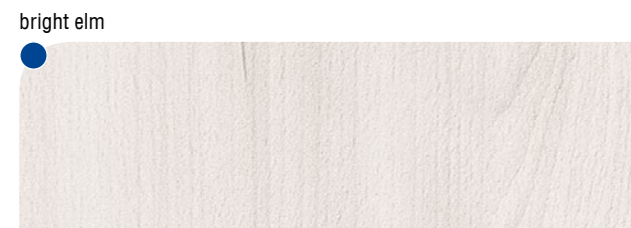

FF

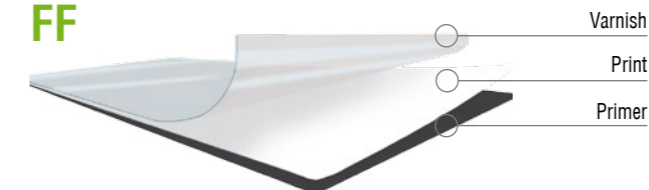

Finish foil: resistant to abrasion.



COLOURS COLLECTION

ADVANTAGES - NON REBATED FRAMED DOOR WINGS

high endurance to mechanical impact

solid construction two hidden 3D hinges, regulated in three planes, third hinge – extra charged



internal section

solid, massive framed construction

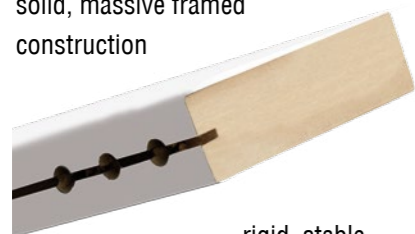

rigid, stable construction



door wing aligned with the door frame creates integrated, aesthetic surface

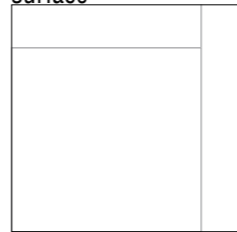

tempered glass

magnetic lock – silent closing



no glazing beads

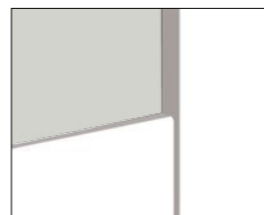

wooden dowels and stabilising feather



ADVANTAGES - REBATED FRAMED DOOR WINGS

high endurance to mechanical impact

solid construction – 3 pintle hinges



internal section

solid, massive framed construction



rigid, stable construction



soft rebate, innovative way of veneering rails: rimless



tempered glass

no glazing beads



profile – brushed aluminium



wooden dowels and stabilising feather



NON-REBATED FRAMED DOOR WINGS



CONSTRUCTION

- **NON-REBATED** FRAMED DOOR WINGS
- MDF RAILS

FINISHING

- VENEERED DOOR WING
- - FF FINISH FOIL, ● - 3D VENEER, ● - CPL LAMINATE, ● - PP PLATINIUM

HARDWARE

- TWO 3D HIDDEN HINGES
- MAGNETIC LOCK FOR KEY, CYLINDER OR BATHROOM LOCK



AVAILABLE WIDTHS

- 60, 70, 80, 90

TECHNICAL INFORMATION PAGE 161-171



ADDITIONAL CHARGES

- VENTILATION CUT
- VENTILATION PVC SLEEVES (EXCLUDING COOLORS COLLECTION)
- BRASS VENTILATION SLEEVES
- DOOR WING 100
- AUTOMATIC THRESHOLD
- THIRD HINGE
- DOUBLE DOOR WINGS
- DARK GREY GLASS AVAILABLE FOR MODEL: MOBI



VSG GLASS

GLASS SMOOTH ON BOTH SIDES



**DOOR WING AVAILABLE
IN CZECH NORM**

REBATED FRAMED DOOR WINGS

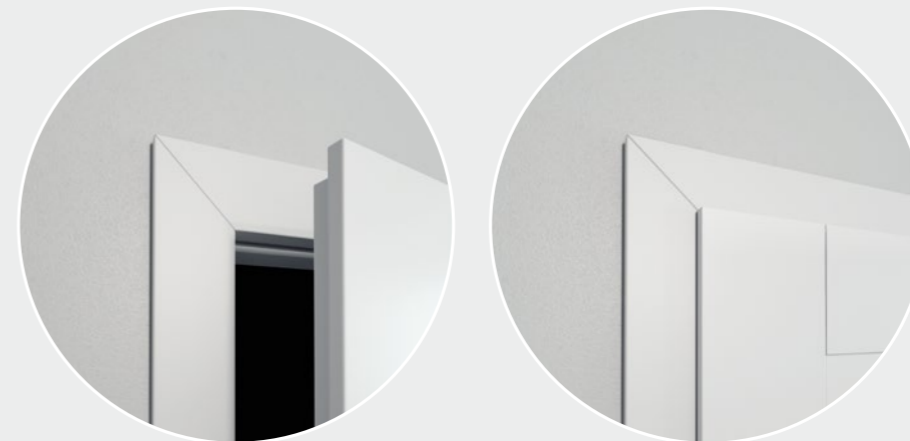

CONSTRUCTION

- **REBATED** FRAMED DOOR WINGS
- MDF RAILS
- WIDTH OF VERTICAL RAILS 14 CM

FINISHING

- VENEERED DOOR WING
- - FF FINISH FOIL, ● - 3D VENEER, ● - CPL LAMINATE, ● - PP PLATINIUM

HARDWARE

- THREE PINTLE HINGES
- LOCK FOR KEY, CYLINDER OR BATHROOM LOCK



AVAILABLE WIDTHS

- 60, 70, 80, 90

TECHNICAL INFORMATION PAGE 161-171



ADDITIONAL CHARGES

- VENTILATION CUT
- VENTILATION PVC SLEEVES
- BRASS VENTILATION SLEEVES
- DOOR WING 100
- AUTOMATIC THRESHOLD
- BLACK HINGES
- DOUBLE DOOR WINGS
- DARK GREY GLASS AVAILABLE FOR MODEL: MOBI, VINCI, VANILLA, ETNA, MODEL Q, MODEL X



VSG GLASS

GLASS SMOOTH ON BOTH SIDES



**DOOR WING AVAILABLE
IN CZECH NORM**

LOFT

NON-REBATED FRAMED
DOOR WINGS

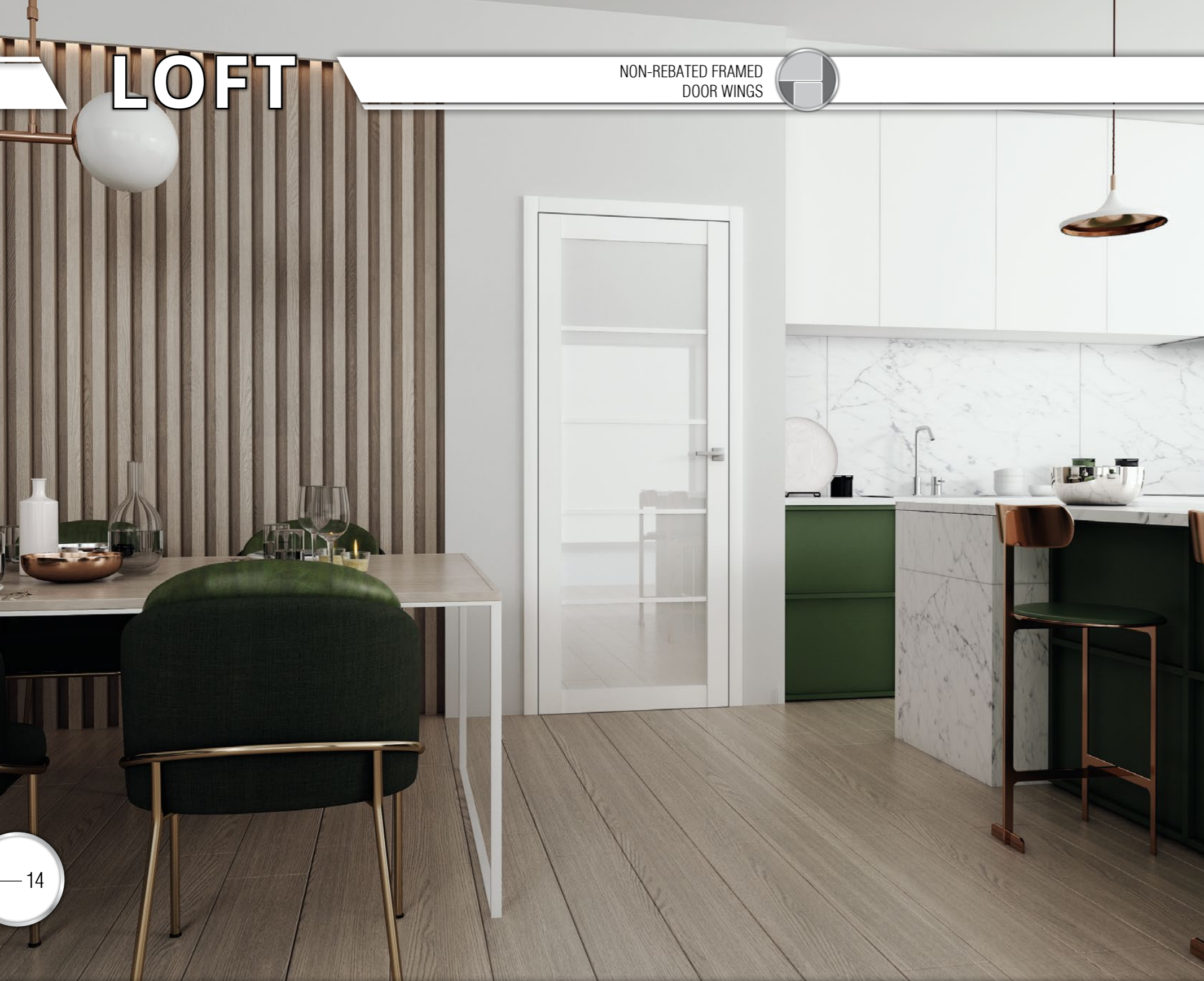

PRESENTED DECOR: WHITE MATT

GLAZING:



LOFT 10
NON-REBATED
TRANSPARENT
GRAPHITE GLASS

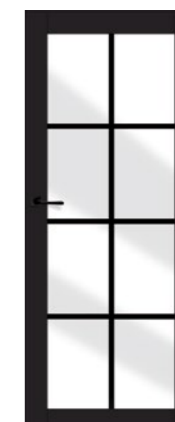

LOFT 20
NON-REBATED
TRANSPARENT
GLASS WITH
PAINTED
APPLICATION



LOFT 30
NON-REBATED
TRANSPARENT
GLASS WITH
PAINTED
APPLICATION



LOFT 40
PAINTED GLASS
WHITE



LOFT 50
PAINTED GLASS
BLACK



LOFT 60
PAINTED GLASS
WHITE



LOFT 70
PAINTED GLASS
BLACK

LOFT 10, 40, 50 MDF PROFILES, IN THE COLOUR OF DOOR WING, GLUED ON GLASS
LOFT 20, 30 APPLICATION PAINTED ON GLASS



AVAILABLE
WIDTHS



VENTILATION
CUT ADDITIONAL
CHARGES
P. 12



TECH. INFO.
P. 161-167



TEMPERED
GLASS



HIDDEN
HINGES



MAGNETIC
LOCK



GLUED VSG SAFE GLASS SMOOTH
ON BOTH SIDES LOFT 40, 50, 60, 70

IT IS POSSIBLE TO MAKE A DOOR WING FOR THE LOFT LINE SLIDING SYSTEM LOFT LINE,
TECHNICAL INFORMATION PAGE 134-135. LOFT DOES NOT FEATURE DOUBLE DOORS

AVAILABLE DECORS:

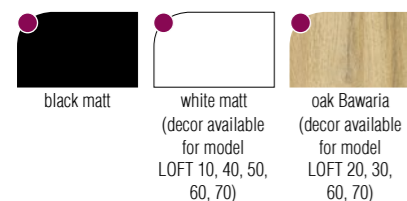

black matt

white matt
(decor available
for model
LOFT 10, 40, 50,
60, 70)

oak Bawaria
(decor available
for model
LOFT 20, 30,
60, 70)

FINISHING – VENEERED DOOR WING:
● – PP PLATINIUM

MEDIOLAN



NON-REBATED FRAMED
DOOR WINGS



GLAZING:



MEDIOLAN 10



MEDIOLAN 20



MEDIOLAN 30

– DOOR FRAMES AVAILABLE IN COLOURS:
BLACK CPL AND BLACK MATT

AVAILABLE DECORS:



FINISHING – VENEERED DOOR WING:
● – PP PLATINIUM

PRESENTED DECOR: BLACK MATT



AVAILABLE
WIDTHS



ADDITIONAL
CHARGES
P. 12



TECH. INFO.
P. 161-167



TEMPERED
GLASS
4 mm



HIDDEN
HINGES



MAGNETIC
LOCK



GLUED VSG SAFE
GLASS SMOOTH
ON BOTH SIDES





PRESENTED DECOR: WHITE MATT

GLAZING:



MOBI 10
NON-REBATED



MOBI 20
NON-REBATED



MOBI 30
NON-REBATED



MOBI 40
NON-REBATED



MOBI 50
NON-REBATED

AVAILABLE DECORS:



FINISHING – VENEERED DOOR WING:
 ● – FINISH FOIL, ● – 3D VENEER
 ● – CPL LAMINATE, ● – PP PLATINIUM



AVAILABLE WIDTHS



TEMPERED GLASS
4 mm



GLUED VSG SAFE GLASS
SMOOTH ON BOTH SIDES



ADDITIONAL CHARGES
P. 12



HIDDEN HINGES



DARK GREY GLASS



TECH. INFO.
P. 161-167



MAGNETIC LOCK



BERGAMO

NON-REBATED FRAMED
DOOR WINGS

VOSTER®



PRESENTED DECOR: SAND OAK CPL

GLAZING:

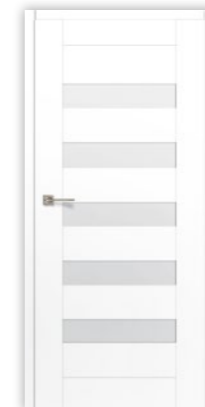

BERGAMO 10
NON-REBATED

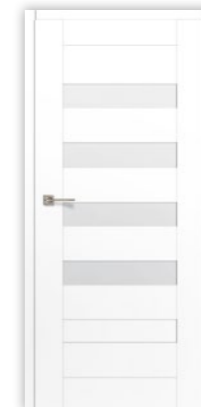

BERGAMO 20
NON-REBATED



BERGAMO 30
NON-REBATED



BERGAMO 40
NON-REBATED



BERGAMO 50
NON-REBATED



BERGAMO 60
NON-REBATED



BERGAMO 70
NON-REBATED

AVAILABLE DECORS:



FINISHING – VENEERED DOOR WING:
 ● – FINISH FOIL ● – 3D VENEER
 ● – CPL LAMINATE, ● – PP PLATINIUM



AVAILABLE
WIDTHS



ADDITIONAL
CHARGES
P. 12



TECH. INFO.
P. 161-167



TEMPERED
GLASS
4 mm



HIDDEN
HINGES



MAGNETIC
LOCK

GRAFO

NON-REBATED FRAMED
DOOR WINGS



VOSTER®



PRESENTED DECOR: OAK CARBON



GRAFO
NON-REBATED



GRAFO
NON-REBATED



GRAFO
NON-REBATED

AVAILABLE DECORS:



FINISHING – VENEERED DOOR WING:
 ● – FINISH FOIL, ● – 3D VENEER
 ● – CPL LAMINATE, ● – PP PLATINIUM



AVAILABLE
WIDTHS



ADDITIONAL
CHARGES
P. 12



TECH. INFO.
P. 161-167



HIDDEN
HINGES



MAGNETIC
LOCK

RUMBA



NON-REBATED FRAMED
DOOR WINGS



VOSTER®



PRESENTED DECOR: WHITE MATT

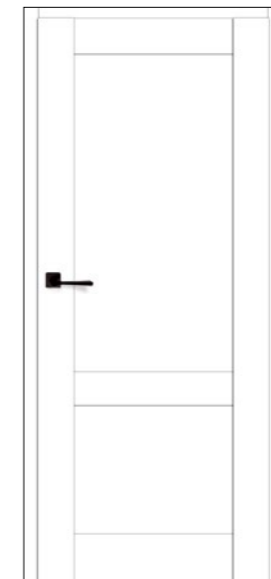

RUMBA NON-REBATED

AVAILABLE DECORS:

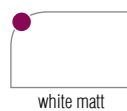

white matt

FINISHING – VENEERED DOOR WING:
● – PP PLATINIUM



AVAILABLE
WIDTHS



ADDITIONAL
CHARGES
P. 12



TECH. INFO.
P. 161-167



HIDDEN
HINGES



MAGNETIC
LOCK

RUMBA



NON-REBATED FRAMED
DOOR WINGS



VOSTER®

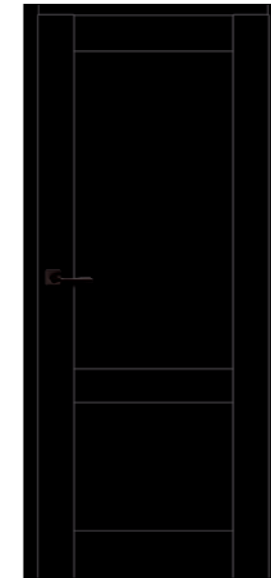
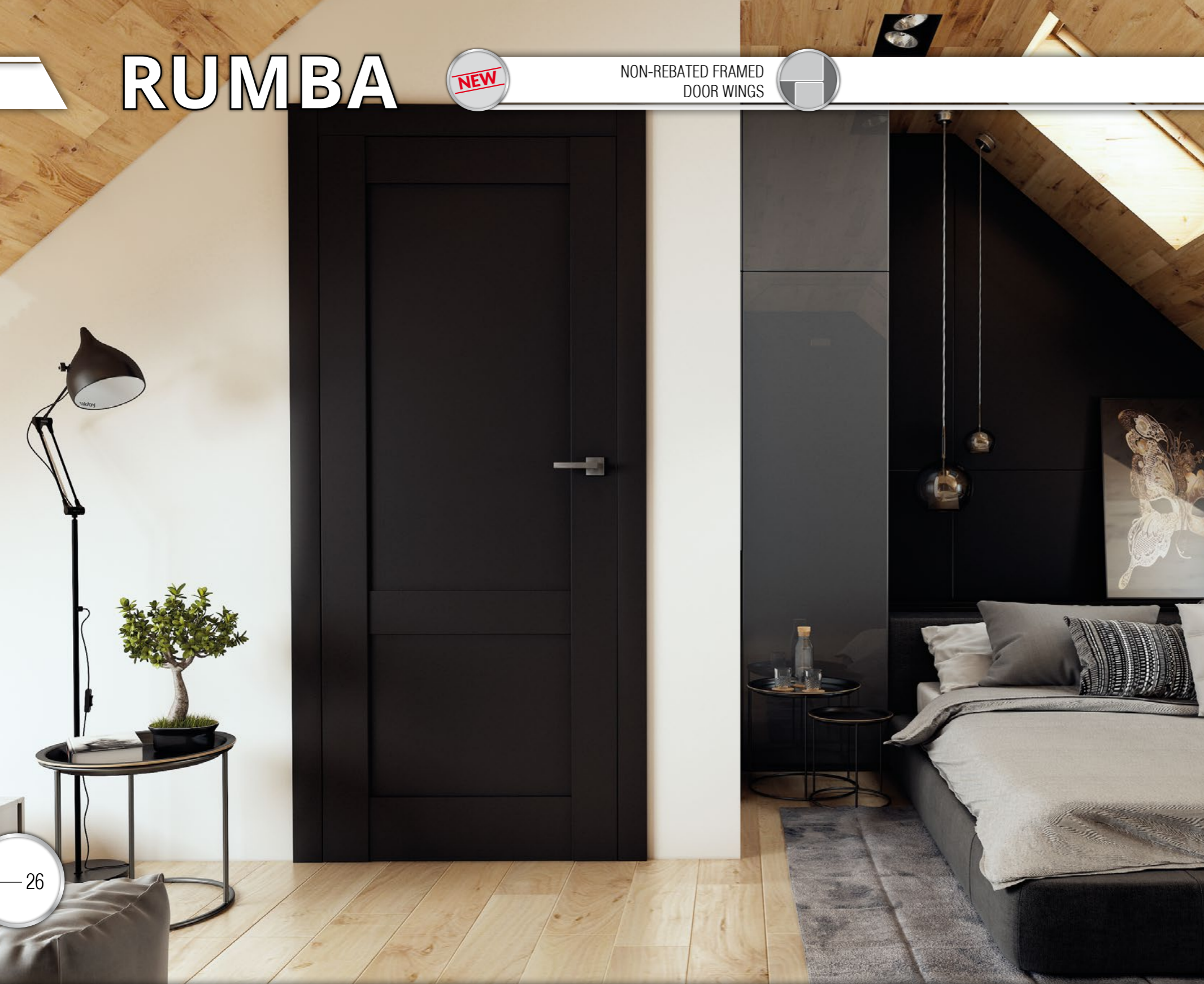

RUMBA NON-REBATED

AVAILABLE DECORS:



black matt

FINISHING – VENEERED DOOR WING:
● – PP PLATINIUM

PRESENTED DECOR: BLACK MATT



AVAILABLE
WIDTHS



ADDITIONAL
CHARGES
P. 12



TECH. INFO.
P. 161-167



HIDDEN
HINGES



MAGNETIC
LOCK

colors

COLLECTION

COLOR IS THE MOST EXCITING OF ALL NATURAL MATTER ON EARTH. IT EXERTS IMPRESSION ON EACH OF US, EVOKES EMOTIONS, HELPS TO TURN HOME INTO A BEAUTIFUL AND FASCINATING PLACE TO LIVE. IT WOULD BE HARD TO IMAGINE LIFE AND THE WORLD WITHOUT COLOUR.

IT IS THE POWER OF COLOURS THAT INSPIRED US TO CREATE THE COLOURS COLLECTION.

COLOURS PLAY A VERY SIGNIFICANT ROLE, THEY ARE INTEGRAL PART OF EVERY AREA OF OUR LIVES. OUR COLLECTION WILL ALLOW YOU TO BRING COLOURS INTO YOUR WORLD.



RUMBA

NON-REBATED FRAMED
DOOR WINGS



colors

VOSTER®



PRESENTED DECOR: PANAMA



RUMBA NON-REBATED



RUMBA NON-REBATED

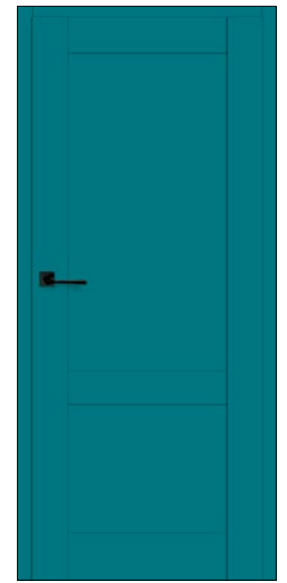

RUMBA NON-REBATED

AVAILABLE DECORS:



Havana

Bahama

Panama

FINISHING – VENEERED DOOR WING:
● – FINISH FOIL



AVAILABLE
WIDTHS



ADDITIONAL
CHARGES
P. 12



TECH. INFO.
P. 161-167



HIDDEN
HINGES



MAGNETIC
LOCK

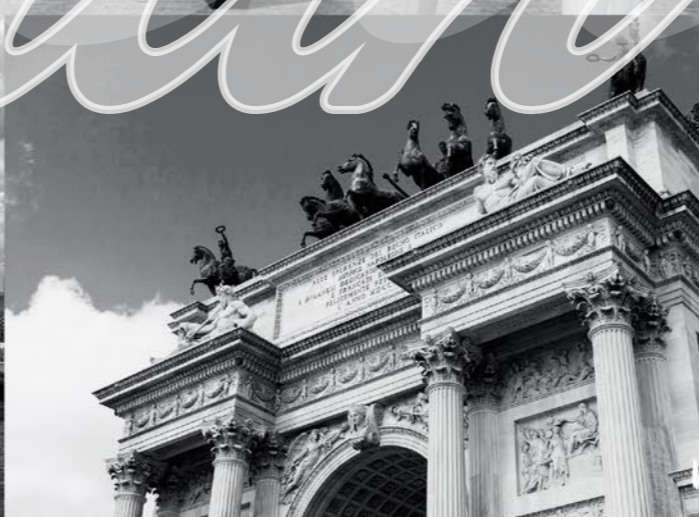

Mediolan

RUMBA

REBATED FRAMED
DOOR WING



VOSTER®

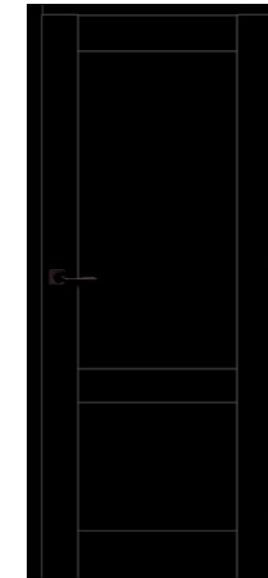

REBATED

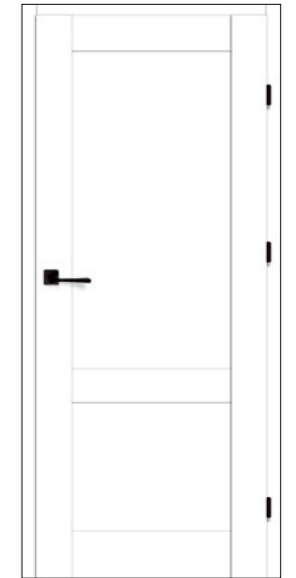

REBATED

PRESENTED DECOR: BLACK MATT; BLACK HINGES – ADDITIONAL CHARGE

AVAILABLE DECORS:

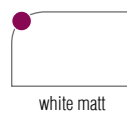

FINISHING – VENEERED DOOR WING:
● – PP PLATINIUM

60/70
80/90
+100
AVAILABLE
WIDTHS

1. ✓
2. ○
3. ✓
+
ADDITIONAL
CHARGES
P. 13



i
TECH. INFO.
P. 161-167



PRESENTED DECOR: BLACK MATT / SAND OAK CPL; BLACK HINGES – ADDITIONAL CHARGE



DUO 10



DUO 20



DUO 20



DUO 20

- DOOR FRAME AVAILABLE IN COLORS: BLACK CPL AND BLACK MATT
- DUO 10 VERTICAL RAILS ONLY IN BLACK MATT

AVAILABLE DECORS:

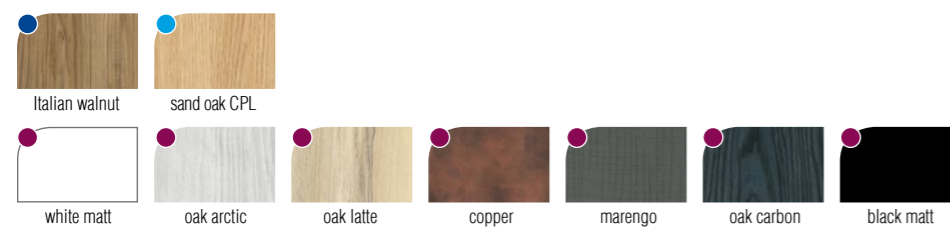

FINISHING – VENEERED DOOR WING:
 ● – FINISH FOIL, ● – 3D VENEER
 ● – CPL LAMINATE, ● – PP PLATINIUM



AVAILABLE WIDTHS



ADDITIONAL CHARGES P. 13



TECH. INFO. P. 161-167





GLAZING:



VINCI 10



VINCI 20



VINCI 30



VINCI 40



VINCI 50

PRESENTED DECOR: WHITE MATT; BLACK HINGES – ADDITIONAL CHARGE

AVAILABLE DECORS:



FINISHING – VENEERED DOOR WING:
 ● – FINISH FOIL, ● – 3D VENEER
 ● – CPL LAMINATE, ● – PP PLATINIUM

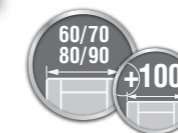

AVAILABLE
WIDTHS



ADDITIONAL
CHARGES
P. 13



TECH. INFO.
P. 161-167



TEMPERED
GLASS
4 mm



DARK GREY
GLASS



GLUED VSG SAFE
GLASS SMOOTH
ON BOTH SIDES



PRESENTED DECOR: OAK CARBON; BLACK HINGES – ADDITIONAL CHARGE

GLAZING:



BELLO 10



BELLO 20

AVAILABLE DECORS:



FINISHING – VENEERED DOOR WING:
● – 3D VENEER, ● – CPL LAMINATE, ● – PP PLATINIUM

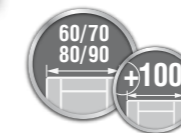

AVAILABLE
WIDTHS



ADDITIONAL
CHARGES
P. 13



TECH. INFO.
P. 161-167



TEMPERED GLASS 4 mm, WIDTH 145 mm (FIXED
DIMENSION FOR ALL DOOR WING WIDTHS)



GLUED VSG SAFE
GLASS SMOOTH
ON BOTH SIDES



PRESENTED DECOR: GRAPHITE MATT

GLAZING:



MOBI 10



MOBI 20



MOBI 30



MOBI 40



MOBI 50

AVAILABLE DECORS:



FINISHING – VENEERED DOOR WING:
 ● – FINISH FOIL, ● – 3D VENEER,
 ● – CPL LAMINATE, ● – PP PLATINIUM

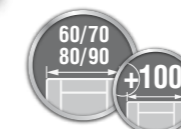

AVAILABLE
WIDTHS



ADDITIONAL
CHARGES
P. 12



TECH. INFO.
P. 161-167



TEMPERED
GLASS
4 mm



DARK GREY
GLASS



GLUED VSG SAFE
GLASS SMOOTH
ON BOTH SIDES

KUBUS

REBATED FRAMED
DOOR WING



VOSTER®



PRESENTED DECOR: WHITE

GLAZING:



KUBUS



LUPUS
GLASS WITHOUT APPLICATION



KUBUS 70



KUBUS 80



KUBUS 90

THE PROPORTION OF THE APPLICATION IN THE 70 WIDE WING DIFFER SLIGHTLY FROM THE APPLICATION IN THE 80 AND 90 WINGS.

AVAILABLE DECORS:



FINISHING – VENEERED DOOR WING:
 – FINISH FOIL, – 3D VENEER,
 – CPL LAMINATE, – PP PLATINIUM



AVAILABLE WIDTHS



ADDITIONAL CHARGES P. 13



TECH. INFO. P. 161-167



TEMPERED GLASS WITH APPLICATION THICKNESS 4 mm



DOOR WING LUPUS

INCANTO

REBATED FRAMED
DOOR WING



VOSTER[®]



PRESENTED DECOR: RUSTICAL OAK

GLAZING:



INCANTO 10



INCANTO 20



INCANTO 30



INCANTO 40



INCANTO 50

AVAILABLE DECORS:



FINISHING – VENEERED DOOR WING:
● – FINISH FOIL, ● – 3D VENEER



AVAILABLE
WIDTHS



ADDITIONAL
CHARGES
P. 13



TECH. INFO.
P. 161-167



TEMPERED
GLASS
4 mm



PRADO

REBATED FRAMED
DOOR WING



VOSTER®



PRESENTED DECOR: BRIGHT ELM

GLAZING:



PRADO 10



PRADO 20



PRADO 30



PRADO 40

AVAILABLE DECORS:



FINISHING – VENEERED DOOR WING:
● – FINISH FOIL, ● – 3D VENEER



AVAILABLE
WIDTHS



ADDITIONAL
CHARGES
P. 13



TECH. INFO.
P. 161-167



TEMPERED
GLASS
4 mm



MURANO

REBATED FRAMED
DOOR WING



VOSTER®



GLAZING:



MURANO 10



MURANO 20



MURANO 30

PRESENTED DECOR: POLAR OAK CPL

AVAILABLE DECORS:



* decors available while stocks last

FINISHING – VENEERED DOOR WING:
 ● – FINISH FOIL, ● – 3D VENEER,
 ● – CPL LAMINATE, ● – PP PLATINUM



AVAILABLE WIDTHS



ADDITIONAL CHARGES
P. 13



TECH. INFO.
P. 161-167



TEMPERED GLASS
4 mm



GLUED VSG SAFE GLASS SMOOTH ON BOTH SIDES

NEUTRA

REBATED FRAMED
DOOR WING



VOSTER®



PRESENTED DECOR: OAK CPL

GLAZING:



NEUTRA 10



NEUTRA 20



NEUTRA 30



NEUTRA 40



NEUTRA 50



PROFILE - BRUSHED
ALUMINIUM

AVAILABLE DECORS:



FINISHING - VENEERED DOOR WING:
● - 3D VENEER, ● - CPL LAMINATE



AVAILABLE
WIDTHS



ADDITIONAL
CHARGES
P. 13



TECH. INFO.
P. 161-167



TEMPERED
GLASS
4 mm



GLUED VSG SAFE
GLASS SMOOTH
ON BOTH SIDES

MEDIOLAN

REBATED FRAMED
DOOR WING



VOSTER®



GLAZING:

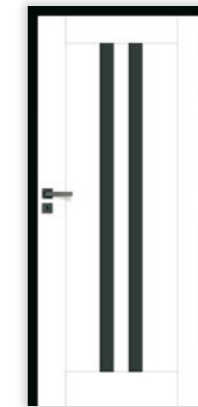

MEDIOLAN 10

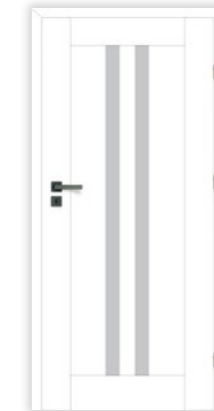

MEDIOLAN 20



MEDIOLAN 30

- DOOR FRAME AVAILABLE IN COLORS: BLACK CPL AND BLACK MATT

PRESENTED DECOR: OIL OAK

AVAILABLE DECORS:



FINISHING – VENEERED DOOR WING:
 ● – 3D VENEER, ● – CPL LAMINATE, ● – PP PLATINIUM
 * decors available while stocks last



AVAILABLE WIDTHS



ADDITIONAL CHARGES
P. 13



TECH. INFO.
P. 161-167



MEDIOLAN 10: GRAPHITE MATT
MEDIOLAN 20: TEMPERED GLASS



GLUED VSG SAFE GLASS SMOOTH
ON BOTH SIDES: GRAPHITE MATT, WHITE

BORNOS

REBATED FRAMED
DOOR WING



VOSTER®



PRESENTED DECOR: SWEDISH OAK

GLAZING:



BORNOS 10



BORNOS 20



BORNOS 30



BORNOS 40



BORNOS 50



BORNOS 60



BORNOS 70



BORNOS 80

AVAILABLE DECORS:



FINISHING – VENEERED DOOR WING:
● – FINISH FOIL, ● – 3D VENEER



AVAILABLE
WIDTHS



BERGAMO

REBATED FRAMED
DOOR WING



VOSTER®



PRESENTED DECOR: BRIGHT ELM

GLAZING:



BERGAMO 10



BERGAMO 20



BERGAMO 30



BERGAMO 40



BERGAMO 50



BERGAMO 60



BERGAMO 70

AVAILABLE DECORS:



FINISHING – VENEERED DOOR WING:
 ● – FINISH FOIL, ● – 3D VENEER,
 ● – CPL LAMINATE, ● – PP PLATINIUM

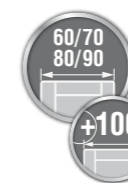

AVAILABLE
WIDTHS



ADDITIONAL
CHARGES
P. 13



TECH. INFO.
P. 161-167



TEMPERED
GLASS
4 mm



GLUED VSG SAFE GLASS SMOOTH
ON BOTH SIDES

MARS

REBATED FRAMED
DOOR WING



VOSTER®



PRESENTED DECOR: MONTANA OAK

GLAZING:



MARS 10



MARS 20



MARS 30



MARS 40

AVAILABLE DECORS:



FINISHING – VENEERED DOOR WING:
 ● – FINISH FOIL, ● – 3D VENEER,
 ● – CPL LAMINATE, ● – PP PLATINIUM





PRESENTED DECOR: OAK CPL

GLAZING:



VICAR 10



VICAR 20



VICAR 30



VICAR 40



VICAR 50

AVAILABLE DECORS:



FINISHING – VENEERED DOOR WING:
 ● – FINISH FOIL, ● – 3D VENEER,
 ● – CPL LAMINATE, ● – PP PLATINIUM



AVAILABLE
WIDTHS



ADDITIONAL
CHARGES
P. 13



TECH. INFO.
P. 161-167



TEMPERED
GLASS
4 mm



GLUED VSG SAFE GLASS
SMOOTH ON BOTH SIDES

TIGA

REBATED FRAMED
DOOR WING



VOSTER®



PRESENTED DECOR: ACACIA CPL

GLAZING:



TIGA 10



TIGA 20



TIGA 30



TIGA 40



PROFILE - BRUSHED
ALUMINIUM

AVAILABLE DECORS:



FINISHING - VENEERED DOOR WING:
● - 3D VENEER, ● - CPL LAMINATE,



AVAILABLE
WIDTHS



ADDITIONAL
CHARGES
P. 13



TECH. INFO.
P. 161-167



TEMPERED
GLASS
4 mm



GLUED VSG SAFE GLASS
SMOOTH ON BOTH SIDES



GLAZING:



TANGO 10



TANGO 20



TANGO 30



TANGO 40

PRESENTED DECOR: ITALIAN WALNUT

AVAILABLE DECORS:



* decors available while stocks last

FINISHING – VENEERED DOOR WING:
 ● – 3D VENEER, ● – CPL LAMINATE,
 ● – PP PLATINIUM

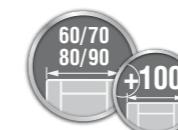

AVAILABLE
WIDTHS



ADDITIONAL
CHARGES
P. 13



TECH. INFO.
P. 161-167



TEMPERED GLASS WITH APPLICATION
(THE APPLICATION OF THE GLAZING IN THE LEFT
WING IS NOT A MIRROR IMAGE IN THE RIGHT WING)





PRESENTED DECOR: SAND OAK CPL; BLACK HINGES – ADDITIONAL CHARGE

GLAZING:



LUGO 10



LUGO 20



LUGO 30



LUGO 40

AVAILABLE DECORS:



* decors available while stocks last

FINISHING – VENEERED DOOR WING:
 ● – 3D VENEER, ● – CPL LAMINATE,
 ● – PP PLATINIUM



AVAILABLE
WIDTHS



ADDITIONAL
CHARGES
P. 13



TECH. INFO.
P. 161-167



TEMPERED
GLASS
4 mm



GLUED VSG SAFE GLASS
SMOOTH ON BOTH SIDES

TOLEDO

REBATED FRAMED
DOOR WING



GLAZING:



TOLEDO 10



TOLEDO 20



TOLEDO 30



TOLEDO 40



TOLEDO 50

PRESENTED DECOR: MUSCATO WALNUT; BLACK HINGES – ADDITIONAL CHARGE

AVAILABLE DECORS:



FINISHING – VENEERED DOOR WING:
 ● – FINISH FOIL, ● – 3D VENEER,
 ● – CPL LAMINATE
 * decors available while stocks last



AVAILABLE
WIDTHS



ADDITIONAL
CHARGES
P. 13



TECH. INFO.
P. 161-167



TEMPERED
GLASS
4 mm



GLUED VSG SAFE GLASS
SMOOTH ON BOTH SIDES

LATINO

REBATED FRAMED
DOOR WING



VOSTER®



PRESENTED DECOR: WHITE CPL

GLAZING:



LATINO 10



LATINO 20



LATINO 30



LATINO 40



LATINO 50



LATINO 60



LATINO 70

AVAILABLE DECORS:



FINISHING – VENEERED DOOR WING:

- – FINISH FOIL
- – 3D VENEER
- – CPL LAMINATE

* decors available while stocks last

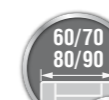

AVAILABLE
WIDTHS



ADDITIONAL
CHARGES
P. 13



TECH. INFO.
P. 161-167



TEMPERED
GLASS
4 mm



GLUED VSG SAFE GLASS
SMOOTH ON BOTH SIDES

BRANDY

REBATED FRAMED
DOOR WING



VOSTER®



PRESENTED DECOR: OLD OAK

GLAZING:



BRANDY 10



BRANDY 20



BRANDY 30



BRANDY 40



BRANDY 50



BRANDY 60



BRANDY 70



BRANDY 80

AVAILABLE DECORS:



* decors available while stocks last

FINISHING - VENEERED DOOR WING:
 ● - FINISH FOIL, ● - 3D VENEER,
 ● - CPL LAMINATE, ● - PP PLATINIUM

75

74



AVAILABLE WIDTHS



ADDITIONAL CHARGES P. 13



TECH. INFO. P. 161-167



TEMPERED GLASS 4 mm



GLUED VSG SAFE GLASS SMOOTH ON BOTH SIDES

ROCCO

REBATED FRAMED
DOOR WING



VOSTER®



PRESENTED DECOR: WHITE FF

GLAZING:



ROCCO 10



ROCCO 20



ROCCO 30



ROCCO 40



ROCCO 50

AVAILABLE DECORS:



FINISHING – VENEERED DOOR WING:
 ● – FINISH FOIL, ● – 3D VENEER,
 ● – CPL LAMINATE, ● – PP PLATINIUM



AVAILABLE WIDTHS



ADDITIONAL CHARGES P. 13



TEMPERED GLASS 4 mm



TECH. INFO. P. 161-167



ZITRON

REBATED FRAMED
DOOR WING



VOSTER®



PRESENTED DECOR: NORWEGIAN OAK

GLAZING:



ZITRON 10



ZITRON 20



ZITRON 30



ZITRON 40



ZITRON 50



ZITRON 60



ZITRON 70



ZITRON 80

AVAILABLE DECORS:



* decors available while stocks last

FINISHING - VENEERED DOOR WING:
 ● - FINISH FOIL, ● - 3D VENEER,
 ● - CPL LAMINATE, ● - PP PLATINIUM



AVAILABLE
WIDTHS



ADDITIONAL
CHARGES
P. 13



TECH. INFO.
P. 161-167



TEMPERED
GLASS
4 mm



GLUED VSG SAFE GLASS
SMOOTH ON BOTH SIDES

VANILLA

REBATED FRAMED
DOOR WING



PRESENTED DECOR: ITALIAN WALNUT; BLACK HINGES – ADDITIONAL CHARGE

GLAZING:



VANILLA 10



VANILLA 20



VANILLA 30



VANILLA 40



VANILLA 50



VANILLA 60



VANILLA 70



VANILLA 80

AVAILABLE DECORS:



* decors available while stocks last

FINISHING – VENEERED DOOR WING:
 ● – FINISH FOIL, ● – 3D VENEER,
 ● – CPL LAMINATE, ● – PP PLATINIUM

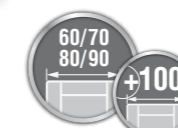

AVAILABLE
WIDTHS



ADDITIONAL
CHARGES
P. 13



TECH. INFO.
P. 161-167



TEMPERED
GLASS
4 mm



DARK GREY
GLASS



GLUED VSG SAFE GLASS
SMOOTH ON BOTH SIDES



PRESENTED DECOR: OIL OAK

GLAZING:



ETNA 10



ETNA 20



ETNA 30



ETNA 40



ETNA 50



ETNA 60



ETNA 70

AVAILABLE DECORS:



* decors available while stocks last

FINISHING – VENEERED DOOR WING:
 ● – FINISH FOIL, ● – 3D VENEER,
 ● – CPL LAMINATE, ● – PP PLATINIUM



AVAILABLE
WIDTHS



ADDITIONAL
CHARGES
P. 13



TECH. INFO.
P. 161-167



TEMPERED
GLASS
4 mm



DARK GREY
GLASS



GLUED VSG SAFE GLASS
SMOOTH ON BOTH SIDES

ANTARES

REBATED FRAMED
DOOR WING



VOSTER®



PRESENTED DECOR: OAK CPL

GLAZING:



ANTARES 10



ANTARES 20



ANTARES 30



ANTARES 40



ANTARES 50

AVAILABLE DECORS:



FINISHING – VENEERED DOOR WING:
● – 3D VENEER, ● – CPL LAMINATE





PRESENTED DECOR: NOBLE OAK

GLAZING:



PRIX 10



PRIX 30



PRIX 50

AVAILABLE DECORS:



FINISHING – VENEERED DOOR WING:

- – 3D VENEER, ● – CPL LAMINATE,
- – PP PLATINIUM

* decors available while stocks last



AVAILABLE
WIDTHS



ADDITIONAL
CHARGES
P. 13



TECH. INFO.
P. 161-167



TEMPERED
GLASS
4 mm



GLUED VSG SAFE GLASS
SMOOTH ON BOTH SIDES

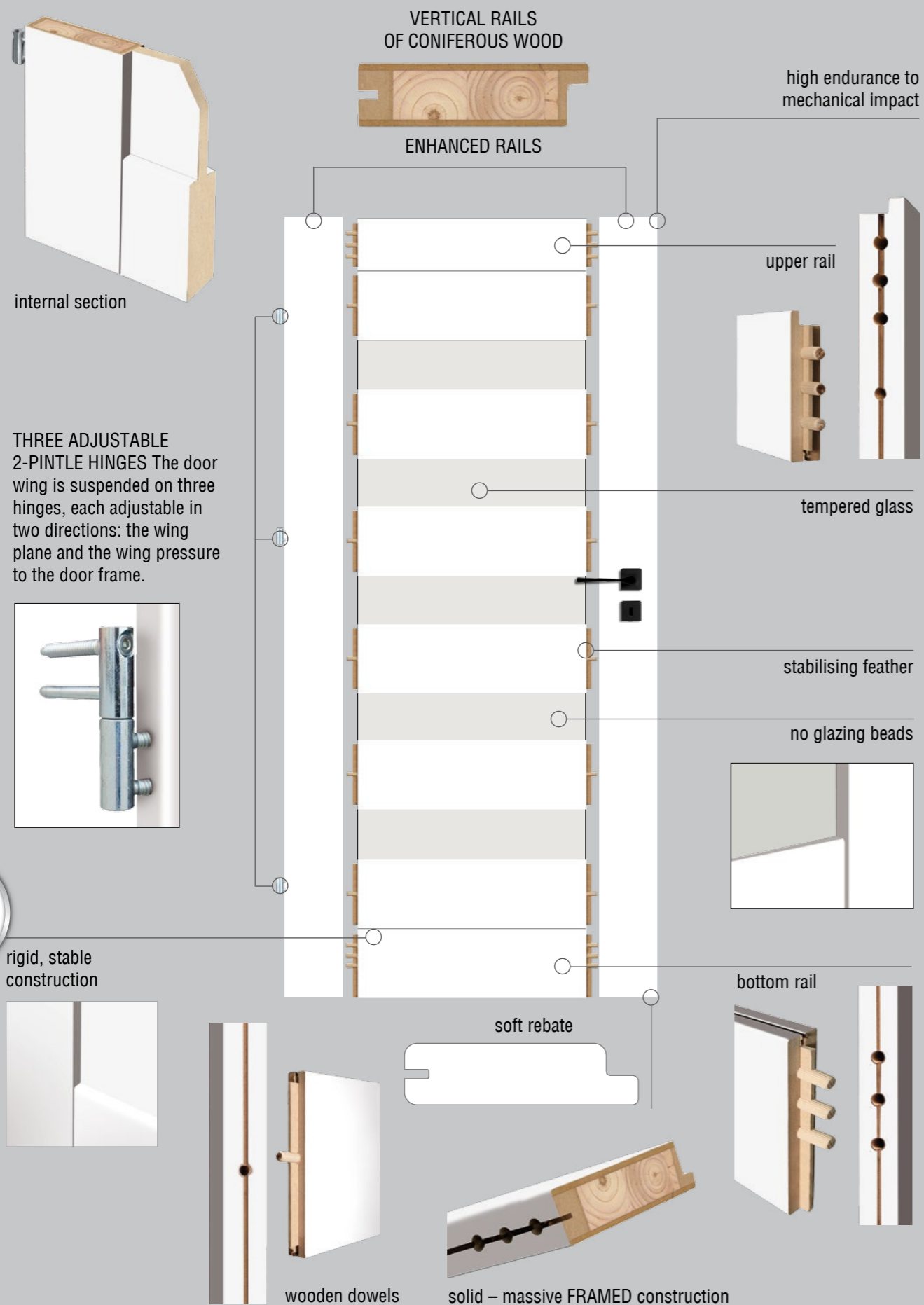

CONSTRUCTION

- FRAMED DOOR WINGS
- MDF RAILS
- WIDTH OF VERTICAL RAILS 14 CM
- VERTICAL RAILS OF CONIFEROUS WOOD (TECH. INFO. P. 164)

FINISHING

- VENEERED DOOR WING: ● – PP PLATINIUM

HARDWARE

- THREE ADJUSTABLE 2-PINTLE HINGES (BLACK HINGES – NOT AVAILABLE)
- LOCK FOR KEY, CYLINDER OR BATHROOM LOCK



GLAZING:

- TEMPERED GLASS 4 MM



AVAILABLE WIDTHS

- 60, 70, 80, 90



TECHNICAL INFORMATION

PAGE 163-164



ADDITIONAL CHARGES

- VENTILATION CUT
- VENTILATION PVC SLEEVES
- BRASS VENTILATION SLEEVES
- DOOR WING 100
- AUTOMATIC THRESHOLD
- DARK GREY GLASS AVAILABLE FOR MODEL: MODEL Q, MODEL X



DOOR WING AVAILABLE

IN CZECH NORM



PP PLATINIUM

white matt

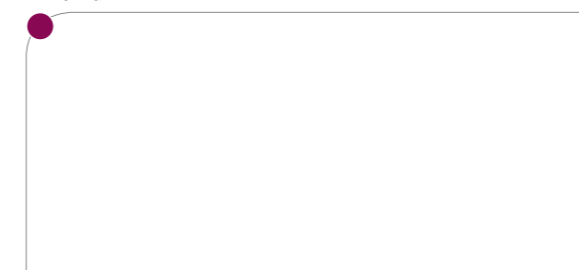

bianco

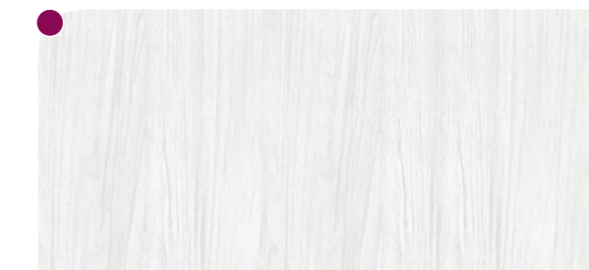

oak latte



oak arctic

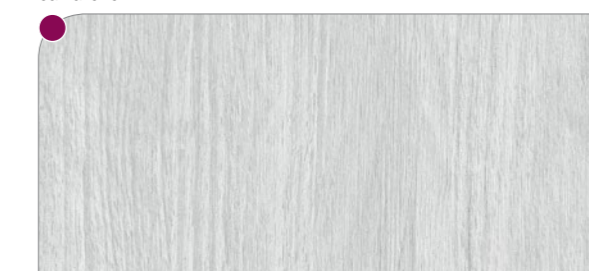

oak Bawaria

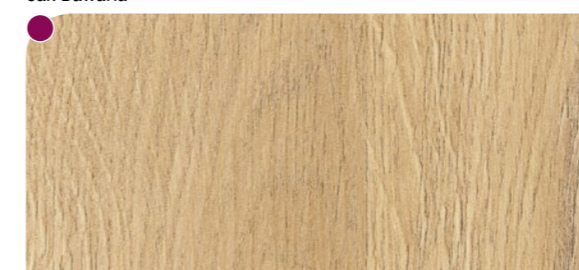

oak carbon

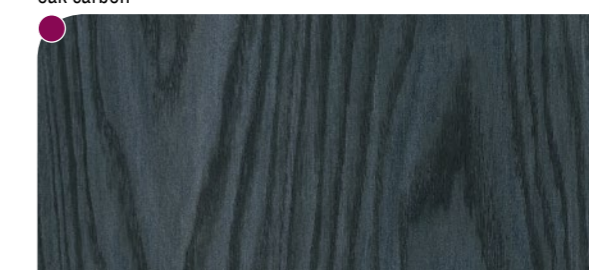

MODEL Q

PLATINIUM

REBATED FRAMED
DOOR WING



VOSTER®



PRESENTED DECOR: WHITE MATT

GLAZING:



MODEL Q 10



MODEL Q 20



MODEL Q 30



MODEL Q 40



MODEL Q 50



MODEL Q 60



MODEL Q 70



MODEL Q 80

AVAILABLE DECORS:

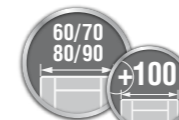

AVAILABLE
WIDTHS



FINISHING - VENEERED DOOR WING:
● - PP PLATINIUM

MODEL X

PLATINIUM

REBATED FRAMED
DOOR WING



PRESENTED DECOR: OAK ARCTIC

GLAZING:



MODEL X 10



MODEL X 20



MODEL X 30



MODEL X 40



MODEL X 50



MODEL X 60



MODEL X 70

AVAILABLE DECORS:



TEMPERED
GLASS
4 mm

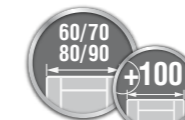

AVAILABLE
WIDTHS



ADDITIONAL
CHARGES
P. 89



TECH. INFO.
P. 163-164



DARK GREY
GLASS



GLUED VSG
SAFE GLASS
SMOOTH ON
BOTH SIDES



FINISHING - VENEERED DOOR WING:
● - PP PLATINIUM

MODEL Y

PLATINIUM

REBATED FRAMED
DOOR WING



VOSTER®



GLAZING:



MODEL Y 10



MODEL Y 20



MODEL Y 30



MODEL Y 40



MODEL Y 50



MODEL Y 60



MODEL Y 70

PRESENTED DECOR: OAK LATTE

AVAILABLE DECORS:



FINISHING – VENEERED DOOR WING:
● – PP PLATINIUM

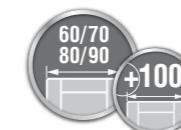

AVAILABLE
WIDTHS



ADDITIONAL
CHARGES
P. 89



TECH. INFO.
P. 163-164



TEMPERED
GLASS
4 mm



GLUED VSG
SAFE GLASS
SMOOTH ON
BOTH SIDES



MODEL V

PLATINIUM

REBATED FRAMED
DOOR WING



VOSTER®



GLAZING:



MODEL V 10



MODEL V 20



MODEL V 30



MODEL V 40



MODEL V 50

PRESENTED DECOR: OAK ARCTIC

AVAILABLE DECORS:



FINISHING – VENEERED DOOR WING:
● – PP PLATINIUM

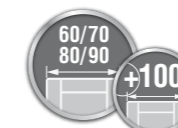

AVAILABLE
WIDTHS



ADDITIONAL
CHARGES
P. 89



TECH. INFO.
P. 163-164



TEMPERED
GLASS
4 mm



GLUED VSG
SAFE GLASS
SMOOTH ON
BOTH SIDES



MONO

REBATED FRAMED
DOOR WING



GLASS
DOOR WING

VOSTER®



PRESENTED DECOR: ACACIA MORAVA

GLAZING



MONO 10

AVAILABLE DECORS:



FINISHING – VENEERED DOOR WING:
 ● – FINISH FOIL ● – 3D VENEER,
 ● – CPL LAMINATE



AVAILABLE
WIDTHS



TECH. INFO.
P. 161-167



TEMPERED GLASS
8 mm

WINDOOR

REBATED FRAMED
DOOR WING



GLASS
DOOR WING

VOSTER®



SZKLENIA:



WINDOOR II



WINDOOR IV



WINDOOR SPAGHETTI

PRESENTED DECOR: MUSCATO WALNUT+ SPAGHETTI GLASS

AVAILABLE DECORS:



FINISHING – VENEERED DOOR WING:
 – FINISH FOIL, – 3D VENEER,
 – CPL LAMINATE, – PP PLATINIUM



70/80/90
AVAILABLE
WIDTHS



TECH. INFO.
P. 161-167



- WINDOOR IV, SPAGHETTI – SATIN GLASS, TEMPERED GLASS, THICKNESS 8 mm, POLISHED EDGES
- WINDOOR II – TEMPERED GLASS, THICKNESS 8 mm, POLISHED EDGES
- WINDOOR SPAGHETTI – TEMPERED GLASS (THE APPLICATION OF THE GLAZING IN THE LEFT WING IS NOT A MIRROR IMAGE IN THE RIGHT WING)



GLAZING:



PLATO
TRANSPARENT



PLATO WHITE



PLATO TRANSPARENT
GRAPHITE

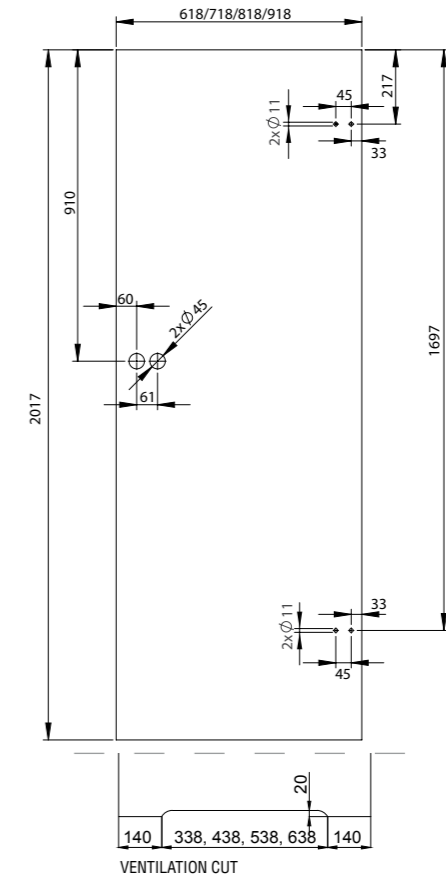

HARDWARE



ADDITIONAL CHARGES

- PLATO DEDICATED ADJUSTABLE FRAME
P. 144
- VENTILATION CUT
- HARDWARE STAINLESS STEEL SET
- 2 HINGES + LOCK (CYLINDER,
ECONOMY)
- HARDWARE STAINLESS STEEL SET
- 2 HINGES + BATHROOM LOCK



AVAILABLE
WIDTHS



TEMPERED GLASS, 8 MM,
POLISHED EDGES



NON-REBATED PLAIN DOOR WINGS

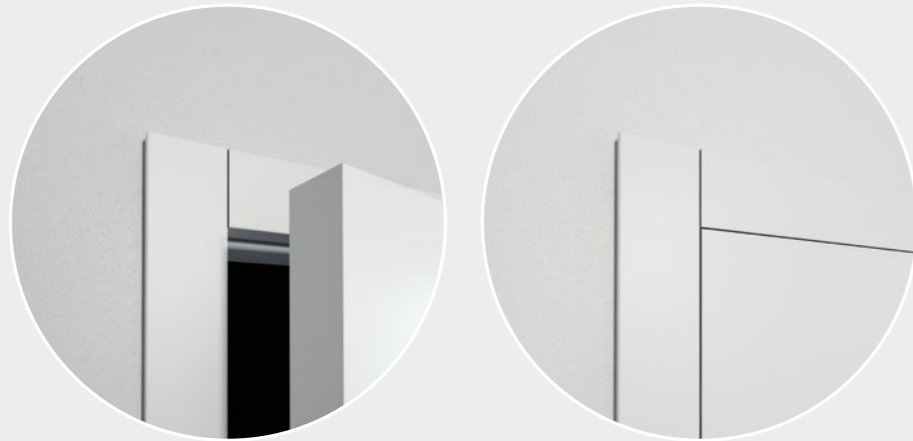

CONSTRUCTION

- **NON-REBATED** FRAMED DOOR WINGS
- MDF RAIL COVERED WITH TWO HDF BOARDS
- STABILISING CORE FILLING 'HONEYCOMB' OR ADDITIONALLY CHARGED 'SOLID BOARD'

FINISHING

- VENEERED HDF BOARDS
- - FF FINISH FOIL, ● - 3D VENEER, ● - CPL LAMINATE, ● - PP PLATINIUM
- ABS RIM Door wings in decors: brass, dark deep blue are wrapped with black ABS rim. The rim does not feature any structure. Slight colour difference may occur between the rim and door wing surface.

HARDWARE

- TWO 3D HIDDEN HINGES
- MAGNETIC LOCK FOR KEY, CYLINDER OR BATHROOM LOCK



AVAILABLE WIDTHS

- 60, 70, 80, 90



TECHNICAL INFORMATION PAGE 161-171



ADDITIONAL CHARGES

- VENTILATION CUT
- VENTILATION PVC SLEEVES
- BRASS VENTILATION SLEEVES
- DOOR WING 100
- AUTOMATIC THRESHOLD
- THIRD HINGE
- ENHANCEMENT - SOLID BOARD
- VENTILATION GRILL
- DOUBLE DOOR WINGS



DOOR WING AVAILABLE IN CZECH NORM



REBATED PLAIN DOOR WINGS



CONSTRUCTION

- **REBATED** FRAMED DOOR WINGS
- MDF RAIL COVERED WITH TWO HDF BOARDS
- STABILISING CORE FILLING 'HONEYCOMB' OR ADDITIONALLY CHARGED 'SOLID BOARD'

FINISHING

- VENEERED HDF BOARDS
- - FF FINISH FOIL, ● - 3D VENEER, ● - CPL LAMINATE, ● - PP PLATINIUM, ● - HDF LAK

HARDWARE

- TWO PINTLE HINGES
- LOCK FOR KEY, CYLINDER OR BATHROOM LOCK



AVAILABLE WIDTHS

- 60, 70, 80, 90



TECHNICAL INFORMATION PAGE 161-171



ADDITIONAL CHARGES

- VENTILATION CUT
- VENTILATION PVC SLEEVES
- BRASS VENTILATION SLEEVES
- DOOR WING 100
- AUTOMATIC THRESHOLD
- BLACK HINGES
- ENHANCEMENT - SOLID BOARD
- PROTECTIVE PANEL INOX BOTTOM (TWO SIDES)
- PROTECTIVE PANEL INOX VENTILATION (TWO SIDES)
- PROTECTIVE PANEL INOX CENTRE (TWO SIDES)
- VENTILATION GRILL
- DOUBLE DOOR WINGS



DOOR WING AVAILABLE IN CZECH NORM



FULL PLAIN



NON-REBATED FRAMED
DOOR WING



FULL PLAIN
NON-REBATED

PRESENTED DECOR: BLACK MATT

AVAILABLE DECORS:



FINISHING - VENEERED DOOR WING:
 - FINISH FOIL, - 3D VENEER,
 - CPL LAMINATE, - PP PLATINIUM



AVAILABLE
WIDTHS



ADDITIONAL
CHARGES
P. 106



TECH. INFO.
P. 161-167



CZ



HIDDEN
HINGES



MAGNETIC
LOCK

FULL PLAIN

TO HIDDEN SYSTEM SARA PRO

NEW

NON-REBATED FRAMED
DOOR WING



VOSTER®



FULL PLAIN

AVAILABLE DECORS:



FINISHING – VENEERED DOOR WING:
 ● – FINISH FOIL, ● – 3D VENEER,
 ● – CPL LAMINATE, ● – PP PLATINIUM

PRESENTED DECOR: BLACK MATT





SARA PRO EXTERIOR

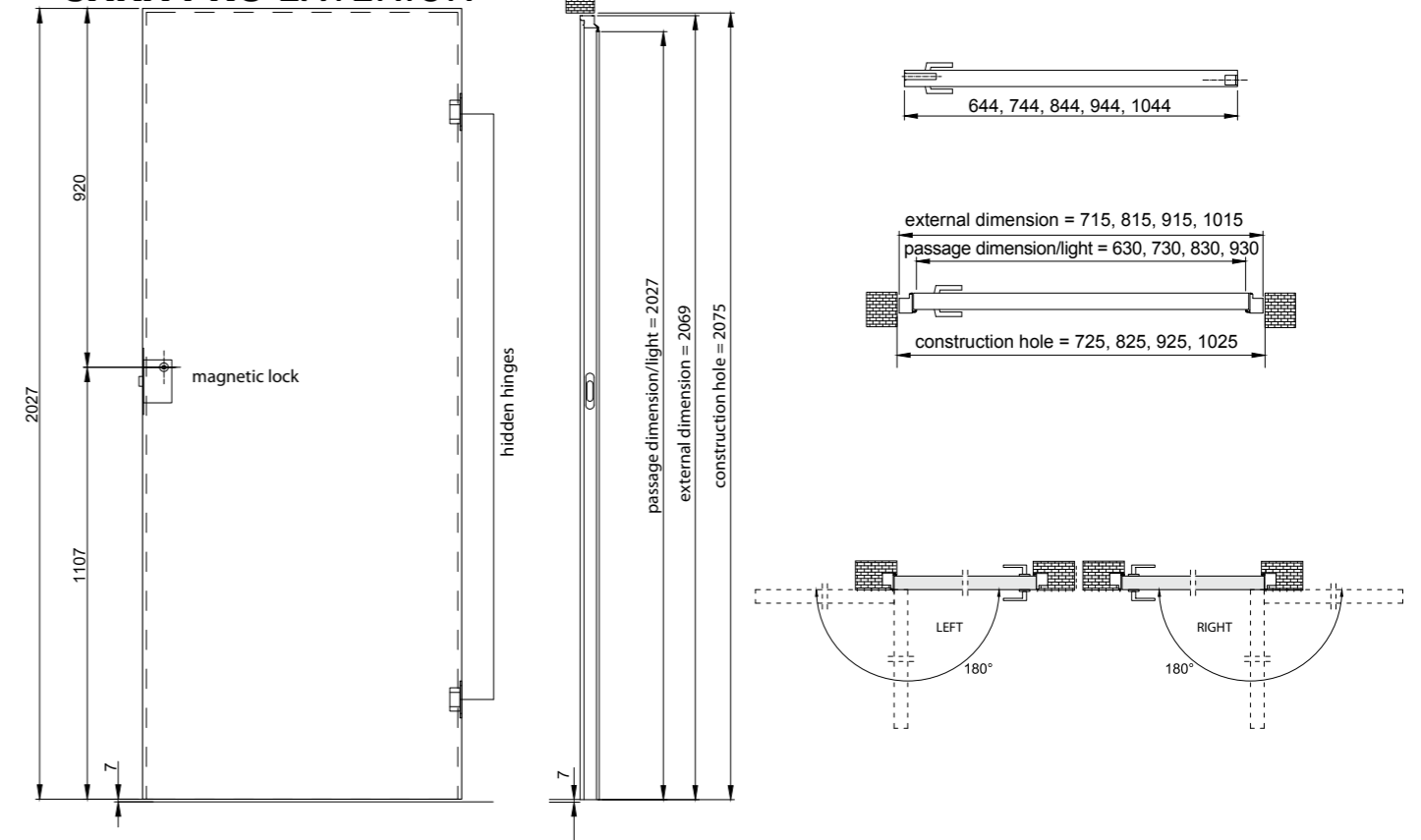

SARA PRO INTERIOR

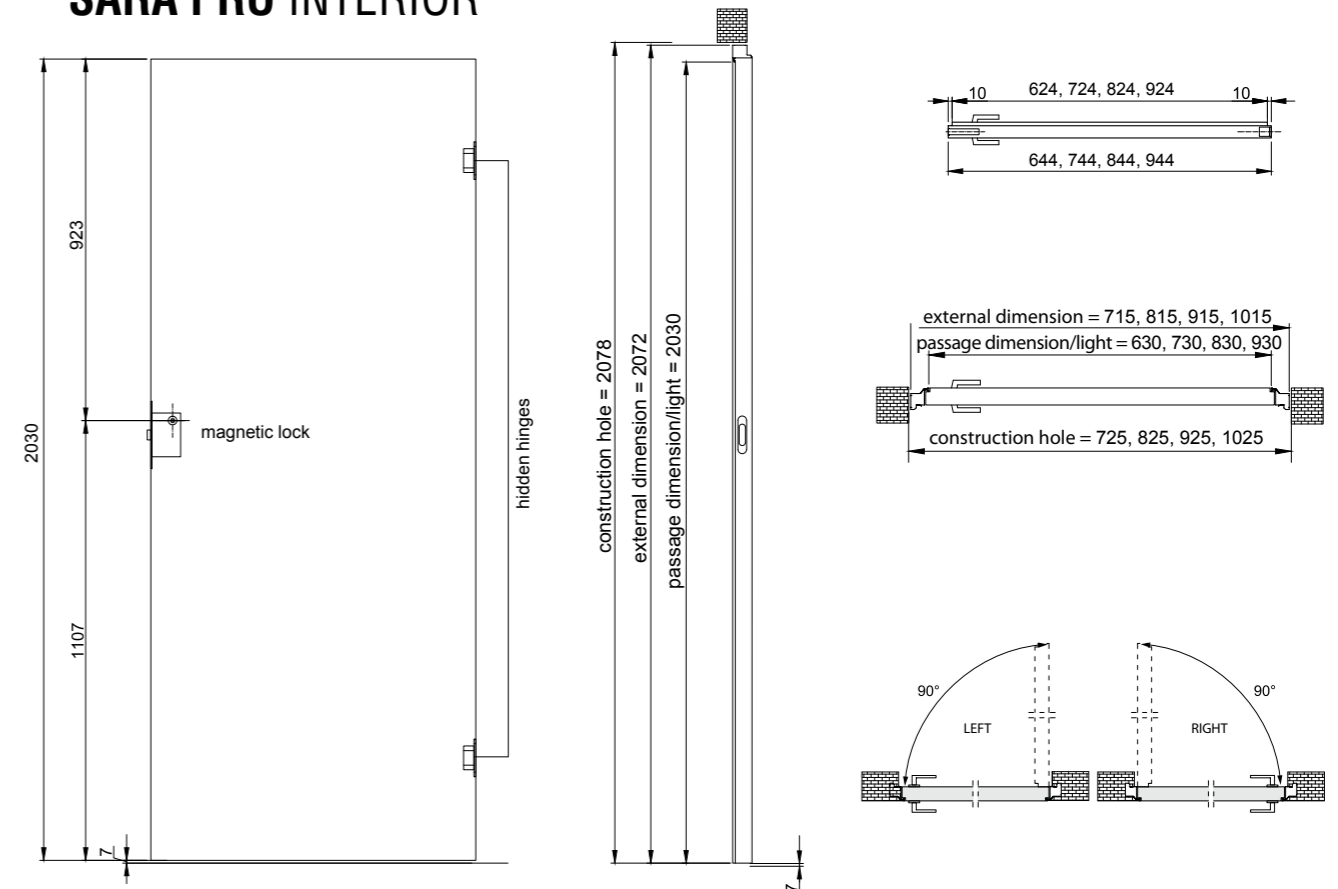

Sara Pro door frame is dedicated to full plain door wings.

The Sara Pro hidden door frame is a unique and durable solution for those looking for new trends in interior design. High-class aluminum, a rigid structure and an improved assembly system make this solution popular, gaining new followers.

Sara PRO is one module-profile, separate for the external and internal system. Sara Pro fits perfectly into minimalist rooms and fits in with the current trends.

Door wing:

- Non-rebated door wing
- 2 3D hidden hinges
- magnetic lock for key, cylinder or bathroom lock
- standard rim



3D hidden hinge



Magnetic lock
- silent closing

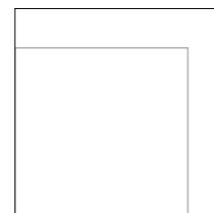

A door wing aligned with wall creates a uniform aesthetic surface



SINGLE CONCEALED DOOR FRAME SARA PRO INTERIOR, EXTERIOR TO WIDTH: 60 – 90, TWO 3D HINGES: ALUMINIUM OR ANODE, PAINTED WHITE

MODERNO

NEW NON-REBATED FRAMED DOOR WING

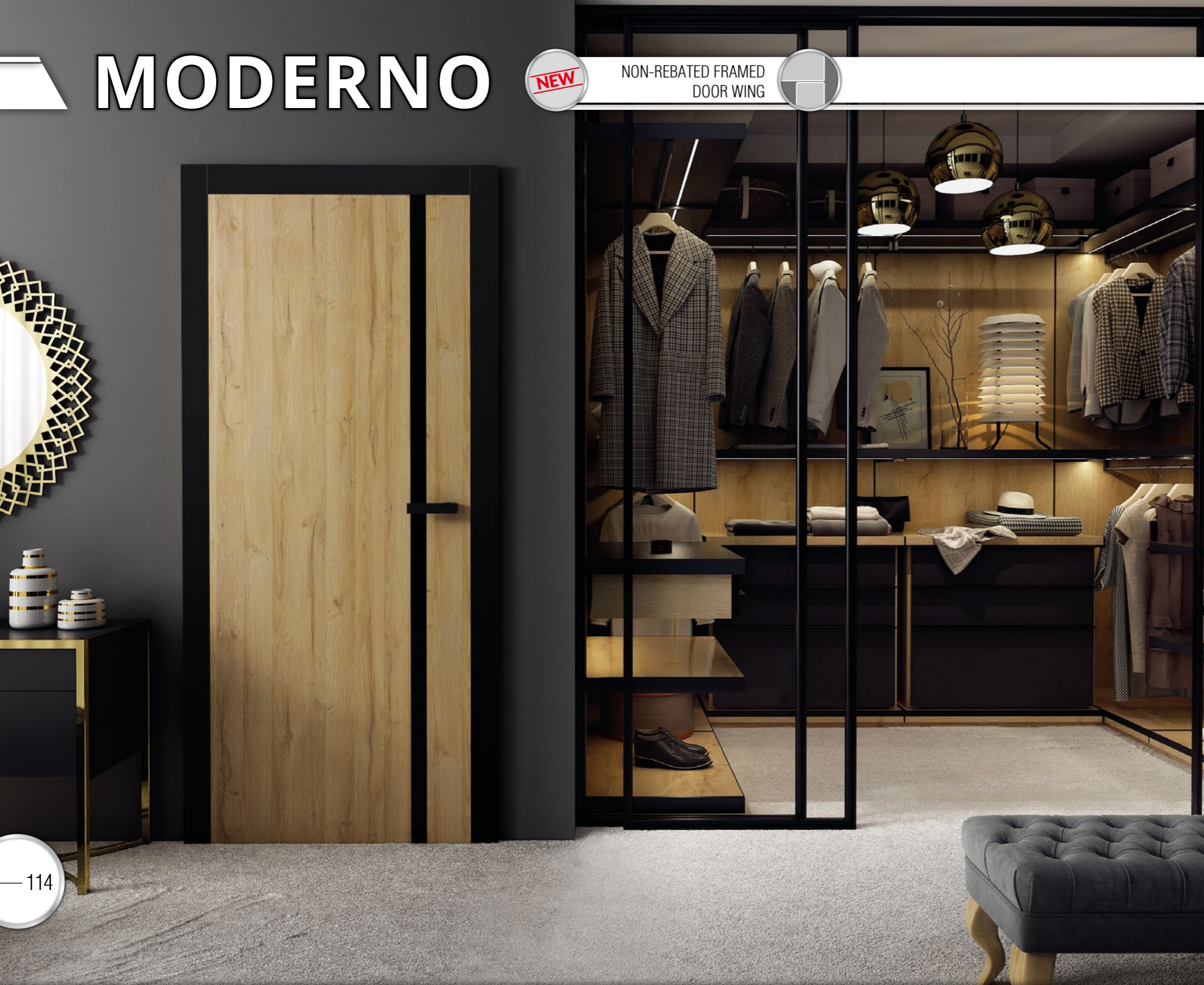

PRESENTED DECOR: OAK BAWARIA

AVAILABLE DECORS:



FINISHING - VENEERED DOOR WING:
 ● - FINISH FOIL, ● - 3D VENEER,
 ● - CPL LAMINATE, ● - PP PLATINIUM



MODERNO NON-REBATED

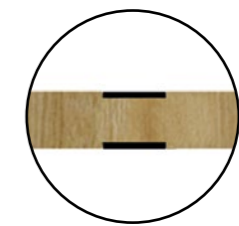

LACOBEL GLASS GLUED IN HDF BOARD



HANDLE PROPOSAL
R8 ONE
 P. 156

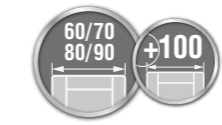

AVAILABLE WIDTHS



ADDITIONAL CHARGES
 P. 106



TECH. INFO.
 P. 161-167



LACOBEL GLASS



HIDDEN HINGES



MAGNETIC LOCK

ENHANCEMENT - SOLID BOARD
 NOT AVAILABLE IN SLIDING SYSTEM



MAGNETIC

NEW NON-REBATED FRAMED DOOR WING



PRESENTED DECOR: GREY

A new version of non-rebated doors. Through the use of an innovative opening and closing system, we have obtained a minimalist and modern form of doors that do not have a traditional lock and handle.

The wing has a block of magnetic stainless steel in the frame and a system of strong magnets. The magnetic force causes the door to close silently and perfectly.

In order to fully close (lock) the door, a small lock with a toilet block or a cylinder lock should be used as an option at an additional cost.

The wing is enhanced with solid board



magnet system – door wing, door frame



LOCK FOR CYLINDER

BATHROOM LOCK



Door wing **Magnetic S**



Door wing **Magnetic L** with long holder

AVAILABLE DECORS:



FINISHING – VENEERED DOOR WING:
● – PP PLATINIUM

FULL PLAIN

NEW

REBATED FRAMED
DOOR WING



FULL PLAIN

PRESENTED DECOR: OAK BAWARIA + BAND 100 OR

AVAILABLE DECORS:



FINISHING – VENEERED DOOR WING:
 ● – FINISH FOIL ● – 3D VENEER,
 ● – CPL LAMINATE, ● – PP PLATINIUM



AVAILABLE WIDTHS

ADDITIONAL CHARGES P. 107

TECH. INFO. P. 161-167



KORA



GLAZED 5/5



GLAZED 2/5

METRIX



GLAZED 2/3



GLAZED 1/3

SOFIA



GLAZED 3/3



GLAZED 1/3

MILANO



GLAZED 4/4



GLAZED 2/4

ALBA



GLAZED 4/4



GLAZED 2/4



The door designed as part of the project entitled Modified panel doors of the standard segment for today, tomorrow, the day after tomorrow and for many years under the Smart Growth Operational Program 2014-2020, Sub-measure 3.2.1 Research for the market. The structure of the product is a consequence of the implementation of the results of R&D works in the field of joinery production technology in the form of internal panel doors (standard segment) with significantly increased strength'.

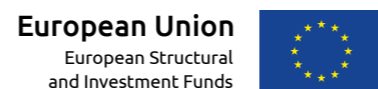

PRESENTED DECOR: SILVER OAK

FULL

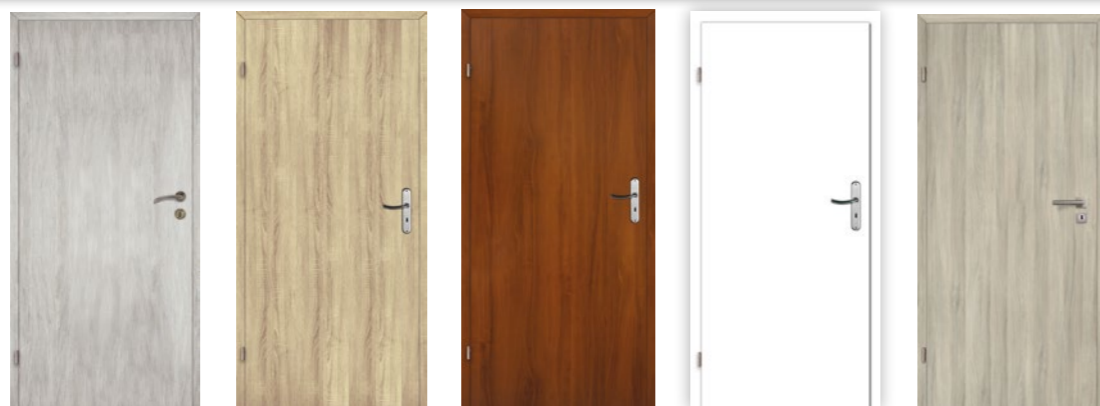

CONSTRUCTION

- MDF RAIL COVERED WITH TWO HDF BOARDS
- STABILISING CORE FILLING 'HONEYCOMB'

FINISHING

- VARNISHED HDF BOARD
- DOOR WINGS MADE IN FELZKANT VERSION
- A COLOUR DIFFERENCE MAY OCCUR BETWEEN THE REBATE AND DOOR WING BOARD

HARDWARE

- TWO PINTLE HINGES
- LOCK FOR KEY, CYLINDER OR BATHROOM LOCK

GLAZING - SATIN GLASS: KORA, SOFIA, MILANO, ALBA, METRIX

ADDITIONAL CHARGE:

- DOOR WING 100 (INFO. PAGE 162)
- ENHANCEMENT - SOLID BOARD (INFO. PAGE 165)
- VENTILATION PVC SLEEVES (THE ADDITIONAL CHARGE CONCERNS DOOR WINGS IN ROOM AND PLAIN VERSIONS).
- ALUMINIUM VENTILATION GRILL
- DOUBLE DOOR WINGS
- AUTOMATIC THRESHOLD

SINGLE FRAMELESS CASSETTE

SLIDING SYSTEM



TABLE OF DIMENSIONS [mm]

Door wing width [Sd]	Door wing height [Hd]	Total system width [C]	Door cassette length [D]	Clear opening width after mounting the frame [E]	Clear opening width before mounting the frame [F]	Cassette depth after mounting the frame [G]	Height of light transition [H]	System total height [H1]
644	2030	1308	640	602	648	654	2018	2115
744		1508	740	702	748	754		
844		1708	840	802	848	854		
944		1908	940	902	948	954		
1044		2108	1040	1002	1048	1054		

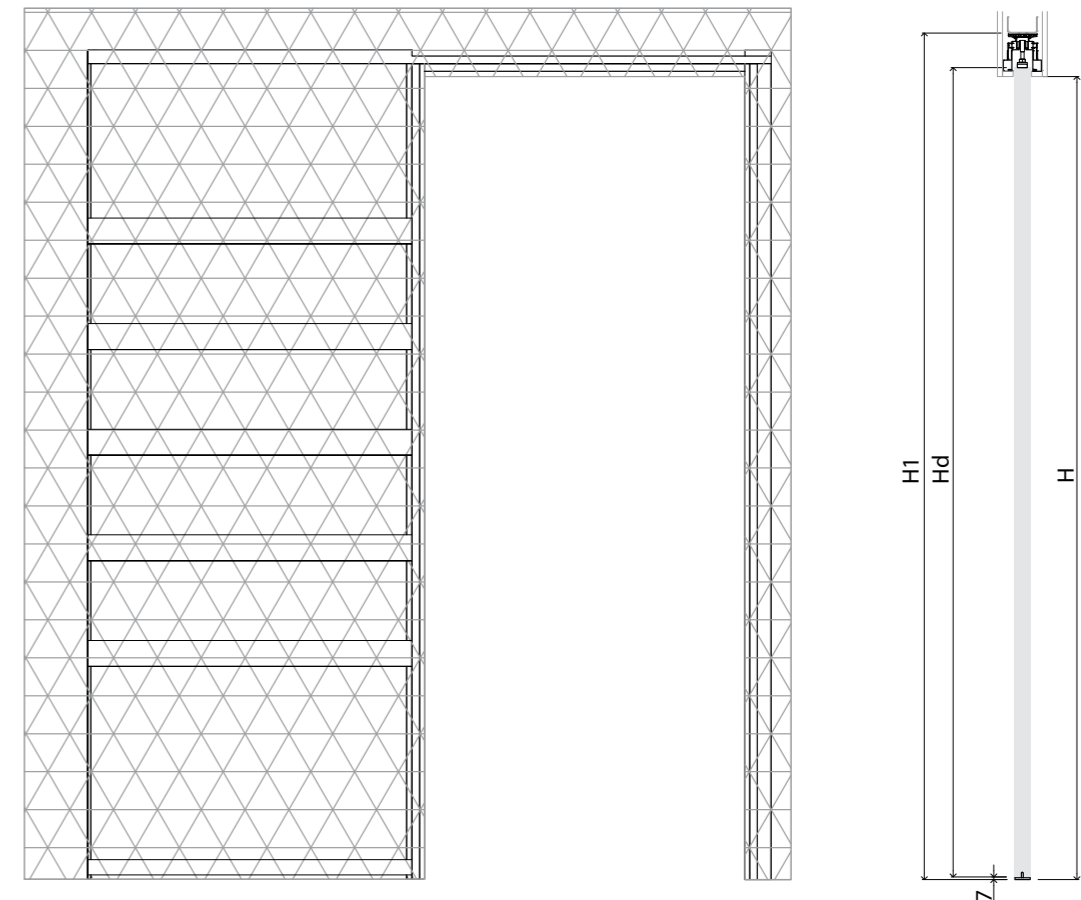

122

The frameless cassette is a sliding system of doors hidden in the wall without the use of a masking band for a gypsum board wall. The frames remain concealed.

The original form gives the arrangement a very modern, slightly austere character. This solution allows for a modern and simple arrangement of rooms.

- Door wing:
- Non-rebated sliding door wing
 - Installed PVC door holder of wing colour

Additionally charged options:

- Steel round holder
- Steel oval holder



Steel round holder colour: silver, graphite



Steel oval holder colour: silver, graphite

SINGLE FRAMELESS CASSETTE	
FRAMED DOOR WINGS	Prices according to the catalogue offer + additional charge page 14 – 97
FULL PANEL PLAIN DOOR WINGS	● Finish Foil, ● CPL, ● PP Platinum
FULL PLAIN VARNISHED DOOR WINGS	Available decors page 120 ● HDF

Non-rebated sliding door wings exclude ventilation cut. Instead ventilation sleeves can be applied.

Non-rebated varnished door wings with non-soft edge (slight colour difference may occur).

123

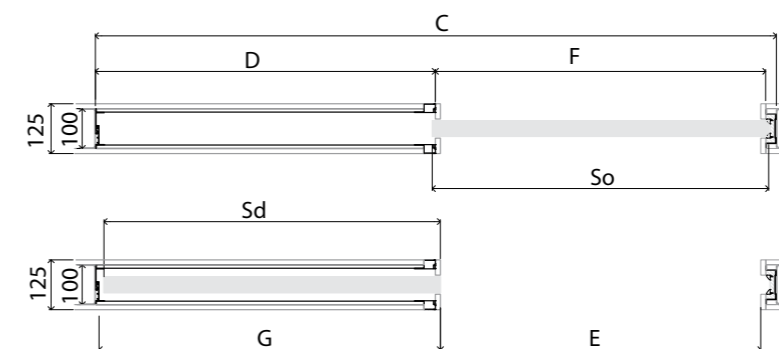

ATTENTION: The door wing cannot be mounted and taken out without disrupting the wall

SINGLE ALUMINIUM SYSTEM G/K



SLIDING SYSTEM



DOOR FRAME FOR SINGLE ALUMINIUM SYSTEM G/K



AVAILABLE DECORS:



FINISHING – VENEERED DOOR WING:
 ● – FINISH FOIL, ● – 3D VENEER,
 ● – CPL LAMINATE, ● – PP PLATINIUM

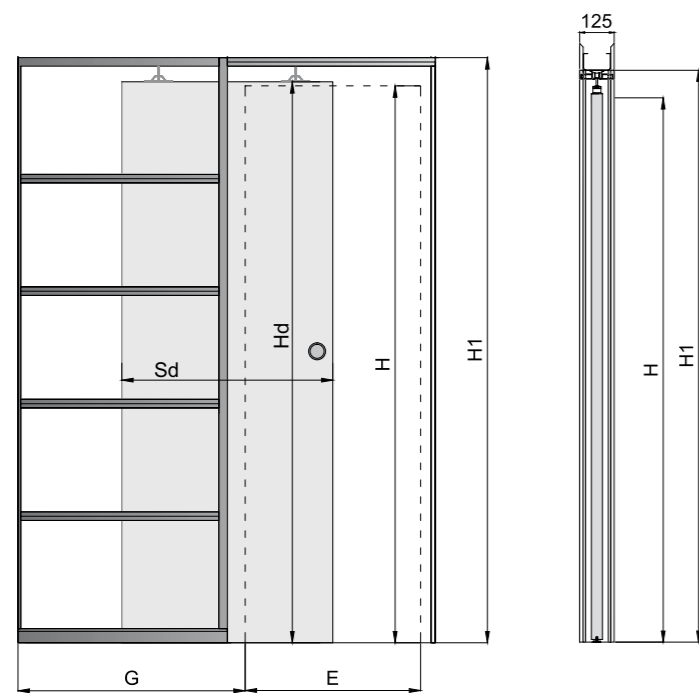

The system for doors hidden in the wall, built-in with gypsum board in the configuration - single system. The system entirely made of aluminum allows to use any type of non-rebated sliding wing (not applicable to glass doors).

Cassette G/K – single aluminium sliding system

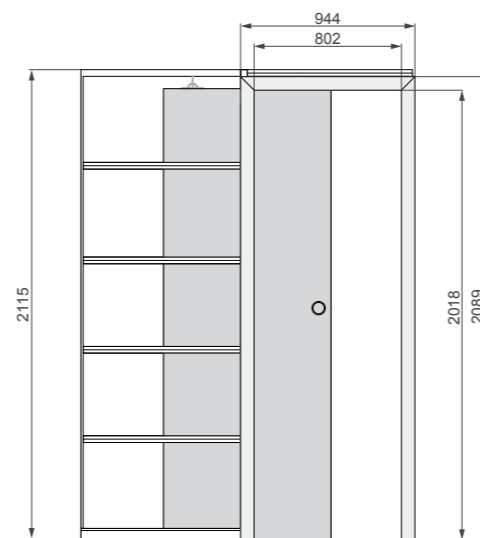
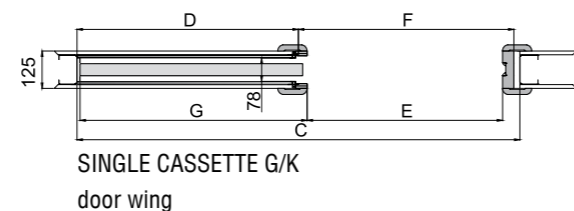

DOOR FRAME RANGE 125 – FIXED

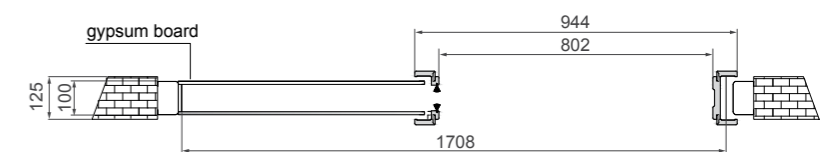

DOOR FRAME RANGE (126-200) – SYMMETRIC*

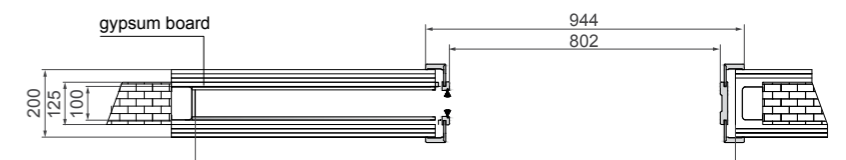

DOOR FRAME RANGE (200-220) TO (400-420) – ASYMMETRIC

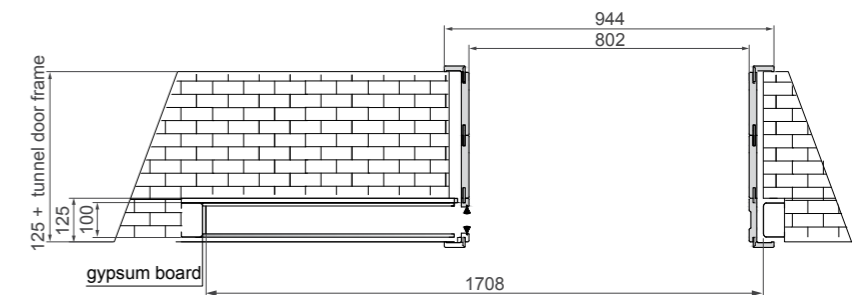

Mounting to system G/K features a masking strip 60 mm

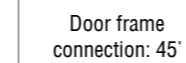

Door frame connection: 45°

● FF ● 3D ● CPL ● PP

Range 125 – FIXED
Range (126-200) – SYMMETRIC*
Range (200-220) – ASYMMETRIC
Range (220-240) – ASYMMETRIC
Range (240-260) – ASYMMETRIC
Range (260-280) – ASYMMETRIC
Range (280-300) – ASYMMETRIC
Range (300-320) – ASYMMETRIC
Range (320-340) – ASYMMETRIC
Range (340-360) – ASYMMETRIC
Range (360-380) – ASYMMETRIC
Range (380-400) – ASYMMETRIC
Range (400-420) – ASYMMETRIC
Range (420-440) – ASYMMETRIC

Door wing width [Sd]	Door wing height [Hd]	Total system width [C]	Door cassette length [D]	Clear opening width after mounting the frame [E]	Clear opening width before mounting the frame [F]	Cassette depth after mounting the frame [G]	Height of light transition [H]	System total height [H1]
644	2030	1308	640	602	648	654	2018	2115
744		1508	740	702	748	754		
844		1708	840	802	848	854		
944		1908	940	902	948	954		
1044		2108	1040	1002	1048	1054		

* Feather square to be trimmed individually to a desired range.

DOUBLE ALUMINIUM SYSTEM G/K

SLIDING SYSTEM

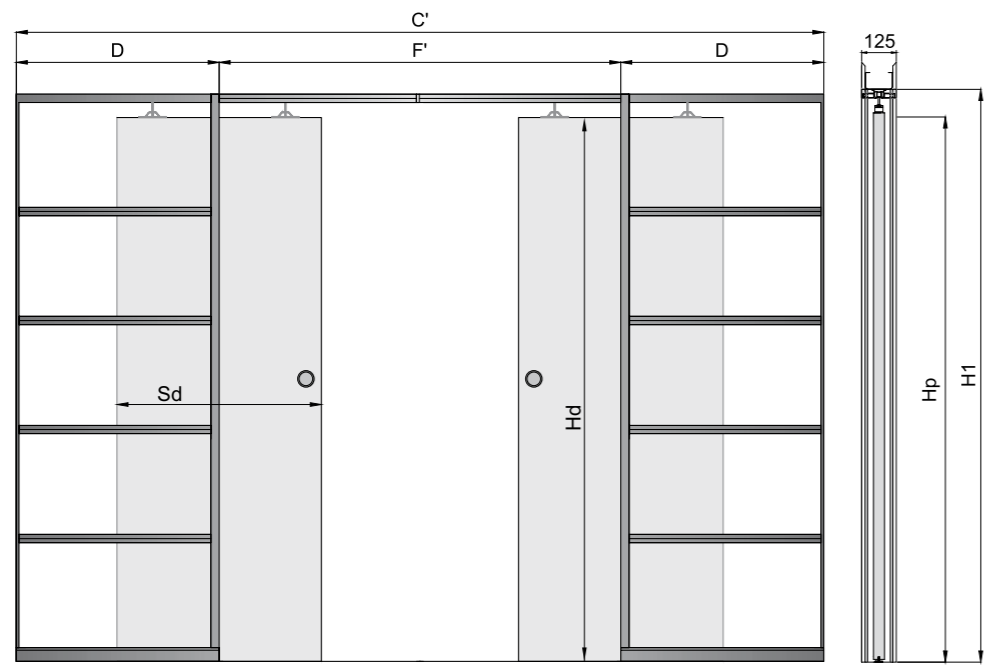

System for the doors hidden in the wall, to be mounted with gypsum board in the configuration - double system. The system made entirely of aluminium allows to use each type of non-rebated door wing (not applicable to glass doors).

Cassette G/K – double aluminium sliding system

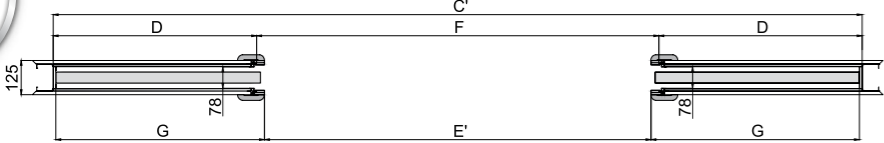

DOUBLE CASSETTE G/K double doors wings

TABLE OF DIMENSIONS [mm]

Door wing width [Sd]	Door wing height [Hd]	Total system width [C']	Door cassette length [D]	Clear opening width after mounting the frame [E']	Clear opening width before mounting the frame [F']	Cassette depth after mounting the frame [G]	Height of light transition [Hp]	System total height [H1]
644	2030	2575	640	1236	1295	653	2018	2115
744		2975	740	1436	1495	753		
844		3375	840	1636	1695	853		
944		3775	940	1836	1895	953		
1044		4175	1040	2036	2095	1053		

DOOR FRAME FOR DOUBLE ALUMINIUM SYSTEM G/K

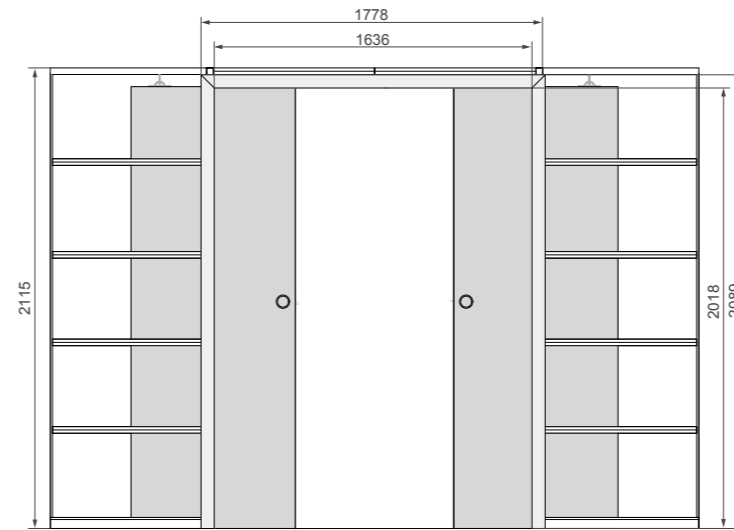

AVAILABLE DECORS:

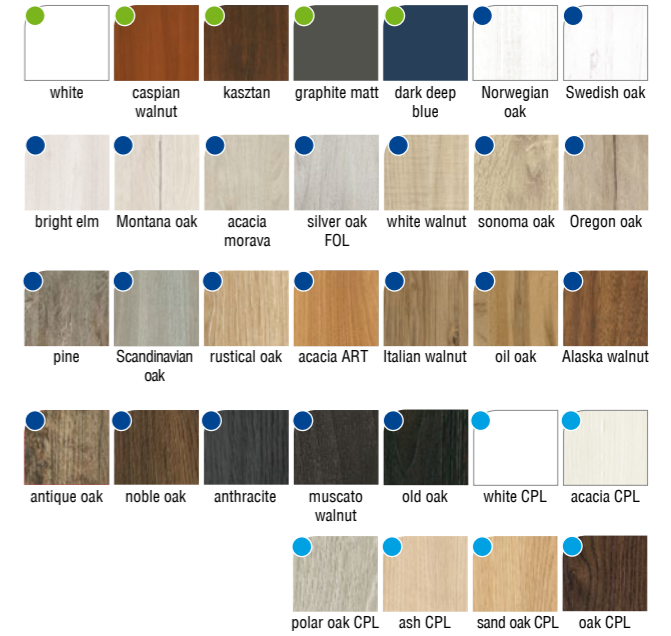

DOOR FRAME RANGE 125 – FIXED

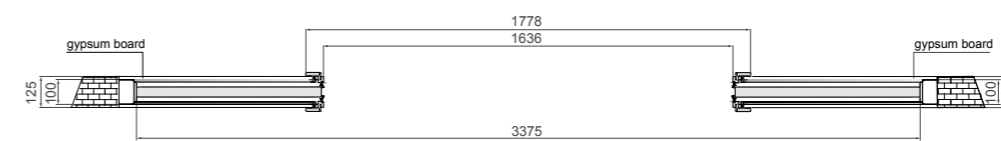

DOOR FRAME RANGE (126-200) – SYMMETRIC*

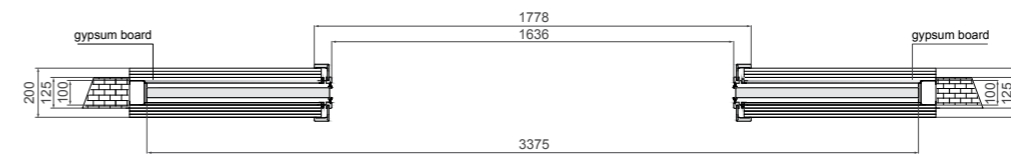

DOOR FRAME RANGE (200-220) TO (400-420) – ASYMMETRIC

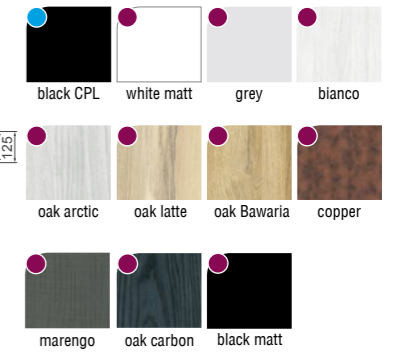
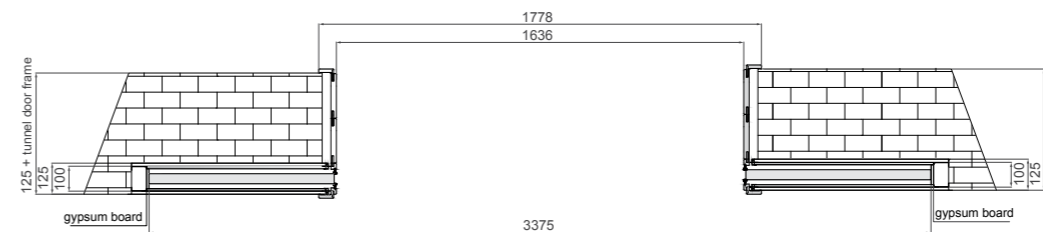

FINISHING:
 ● – FINISH FOIL, ● – 3D VENEER
 ● – CPL LAMINATE, ● – PP PLATINIUM

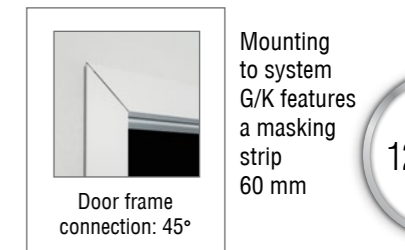

● FF	● 3D	● CPL	● PP
Range 125 – FIXED			
Range (126-200) – SYMMETRIC*			
Range (200-220) – ASYMMETRIC			
Range (220-240) – ASYMMETRIC			
Range (240-260) – ASYMMETRIC			
Range (260-280) – ASYMMETRIC			
Range (280-300) – ASYMMETRIC			
Range (300-320) – ASYMMETRIC			
Range (320-340) – ASYMMETRIC			
Range (340-360) – ASYMMETRIC			
Range (360-380) – ASYMMETRIC			
Range (380-400) – ASYMMETRIC			
Range (400-420) – ASYMMETRIC			
Range (420-440) – ASYMMETRIC			

* Feather square to be trimmed individually to a desired range.

SINGLE ON-WALL SYSTEM

SLIDING SYSTEM



This solution allows for an easy and simple way of installing the rail and the door wing without disrupting the existing wall. Door wing slides along the wall on the rail mounted above the door opening or to the lintel. The system includes: aluminium rail 200 cm long (SN 200/100 kg), carriages, mounting elements and the masking band (curtain rail). It is possible to make a single on-wall sliding system with curtain rail of length 150 cm. Sliding system (aluminium rail + masking trim, length 200 or 150 cm, for door wings 100 cm wide a system 220 cm long is recommended: ● FF ● 3D ● CPL ● PP

- Door wing:
- Non-rebated sliding door wing
 - Installed PVC door holder of wing colour

- Additional charges:
- Adjustable tunnel frame
 - Fender beam: ● FF ● 3D ● CPL ● PP
 - Steel round holder
 - Steel oval holder*
 - Hook lock
 - Door closer

FRAMED DOOR WINGS	Prices according to the catalogue offer + additional charge page 14 – 97
FULL PANEL PLAIN DOOR WINGS	● Finish Foil, ● CPL, ● PP Platinum
FULL PLAIN VARNISHED DOOR WINGS	Available decors page 120 ● HDF
GALZED PLAIN VARNISHED DOOR WINGS	Prices according to the catalogue offer + additional charge page 121

Non-rebated painted door wing made with the edge in non-soft technology (slight colour difference might occur).

Non-rebated door wings do not feature ventilation cut. Ventilation sleeves can be provided.

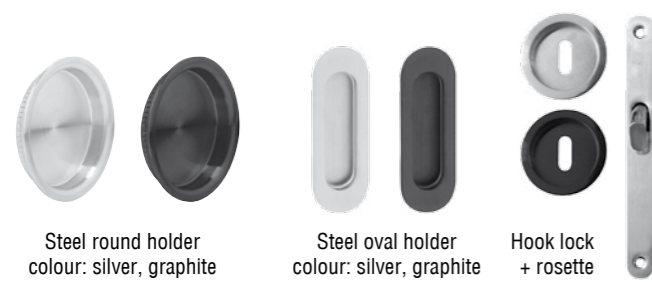
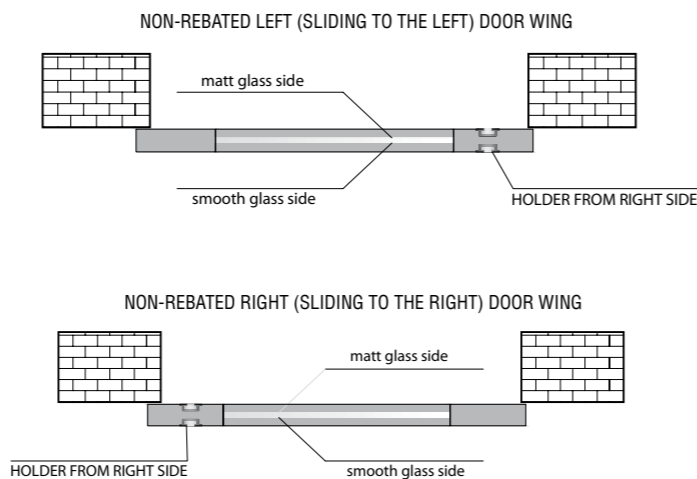

* oval holder does not feature installing hook lock

DOOR CLOSER - slows the movement of the door wing in the final phase of its closing, aligning it gently into the frame. Increases doors use safety and prevents the wing from bumping onto the door frame.

For interior doors, excluding glass doors.

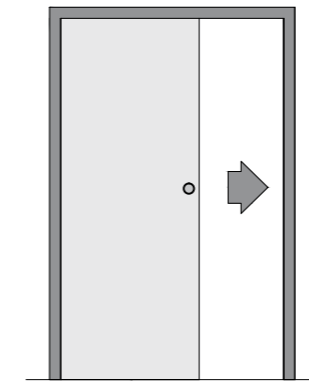

TUNNEL MOUNTING

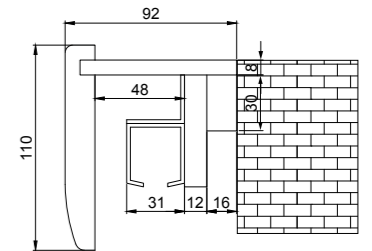

MASKING TRIM (CURTAIN RAIL)

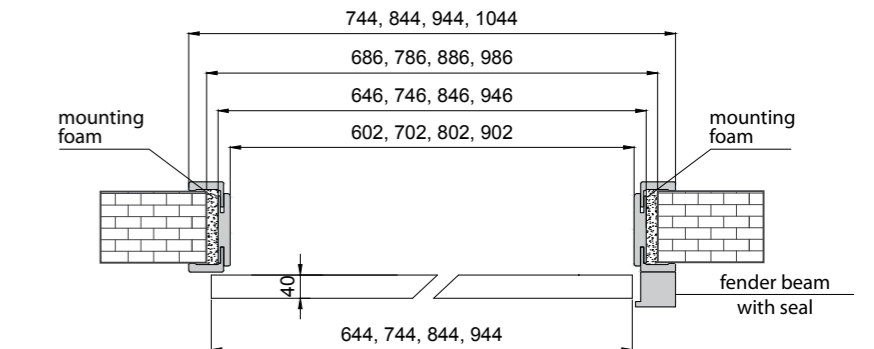
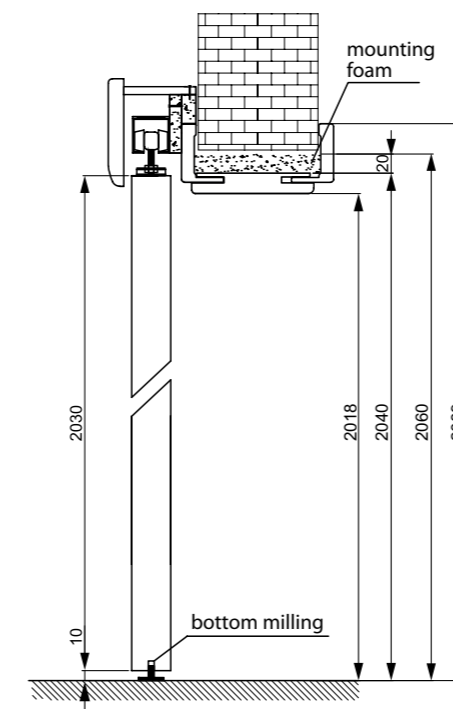
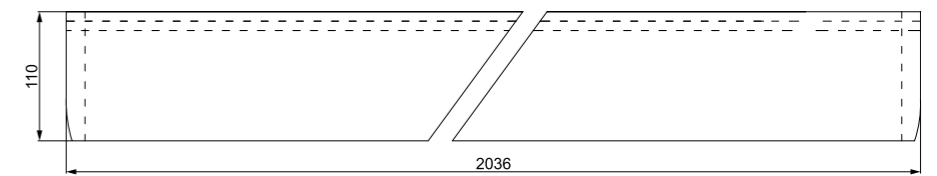

FENDER BEAM

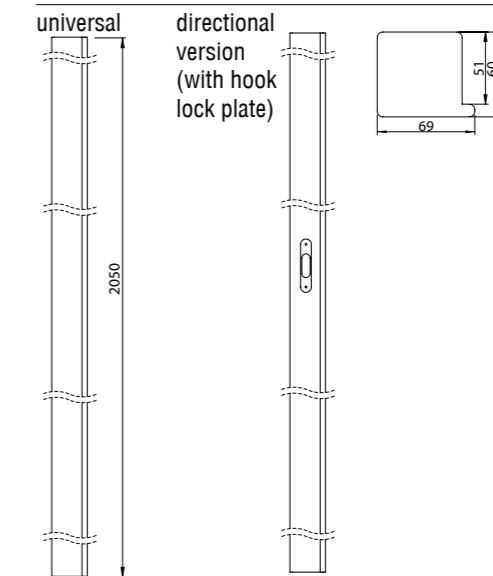

WITHOUT MOUNTING

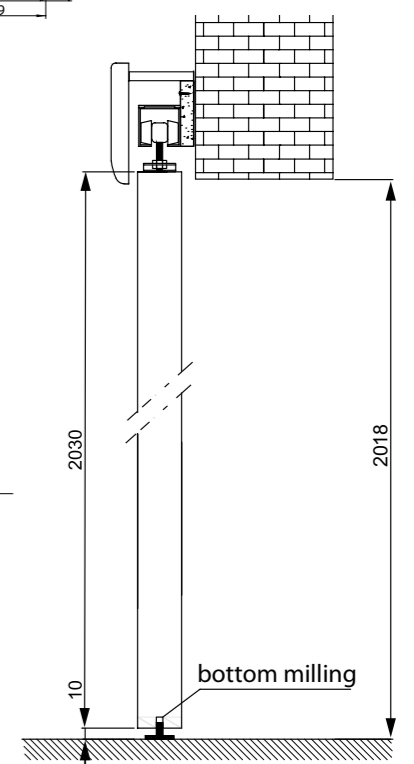
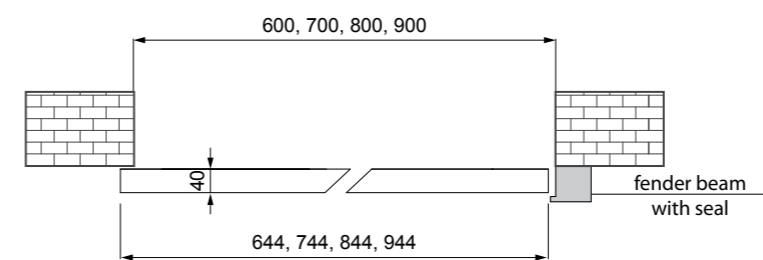

DOUBLE ON-WALL SYSTEM

SLIDING SYSTEM



SYNCH TO DOUBLE SYSTEM

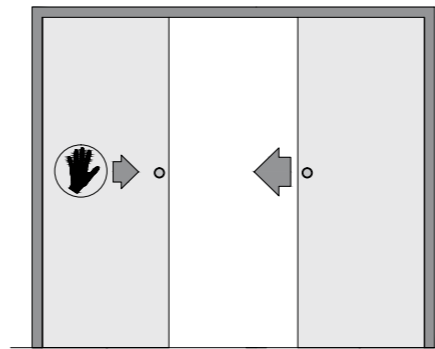

Synch system synchronises the movement of door wings in double door system; moving one wing causes analogous movement of the other wing.
For interior doors, excluding glass doors.

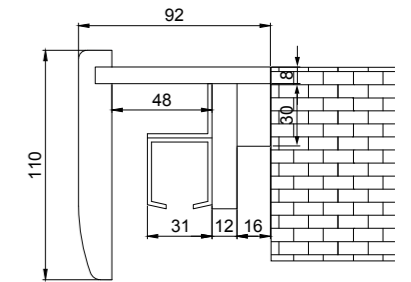

MASKING TRIM (CURTAIN RAIL)

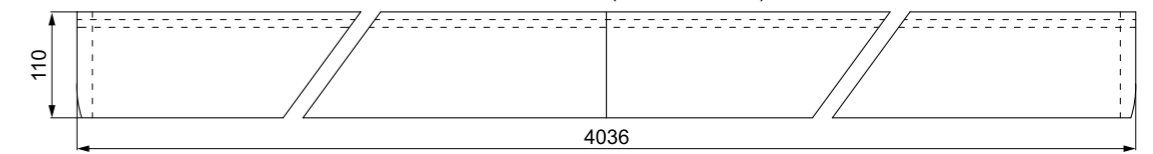

This solution allows for an easy and simple way of installing the rails and the door wings without disrupting the existing wall. Door wings slide along the wall on the rails mounted above the door opening or to the lintel. Standard system set includes: aluminium rail 2x length 200 cm long (SN 200/100 kg), carriages, mounting elements and the two-element masking band (curtain rail). It is possible to make a double on-wall sliding system with aluminium rail of length 2 x 150 cm.

Double sliding system (2x aluminium rail + two-element masking trim): ● FF ● 3D ● CPL ● PP

- Door wing:
- Non-rebated sliding door wing
 - Installed PVC door holder of wing colour

- Additional charges:
- Adjustable tunnel frame
 - Steel round holder
 - Steel oval holder*
 - Hook lock
 - Door closer
 - Synch to double system

FRAMED DOOR WINGS	Prices according to the catalogue offer + additional charge page 14 - 97
FULL PANEL PLAIN DOOR WINGS	● Finish Foil, ● CPL, ● PP Platinum
FULL PLAIN VARNISHED DOOR WINGS	Available decors page 120 ● HDF
GALZED PLAIN VARNISHED DOOR WINGS	Prices according to the catalogue offer + additional charge page 121

Non-rebated varnished door wings are made in non-soft technology (a slight colour difference may occur). Non-rebated door wings do not feature ventilation cut. Ventilation sleeves can be provided. Models: Tango, Antares - glass panel application in the left wing does not constitute a reflection in the right wing.

If hook lock is ordered to double sliding door wing, the other door wing must feature a steel holder and hook lock plate.

TUNNEL MOUNTING

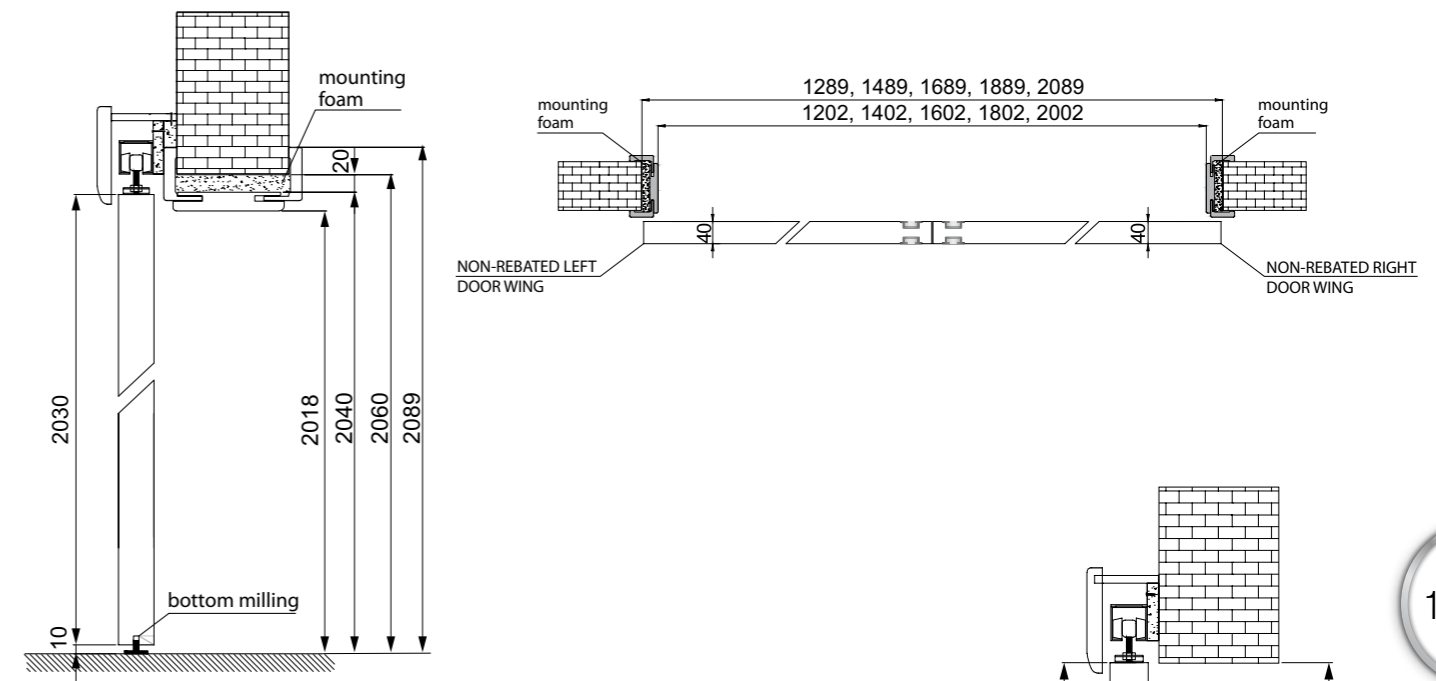

WITHOUT MOUNTING

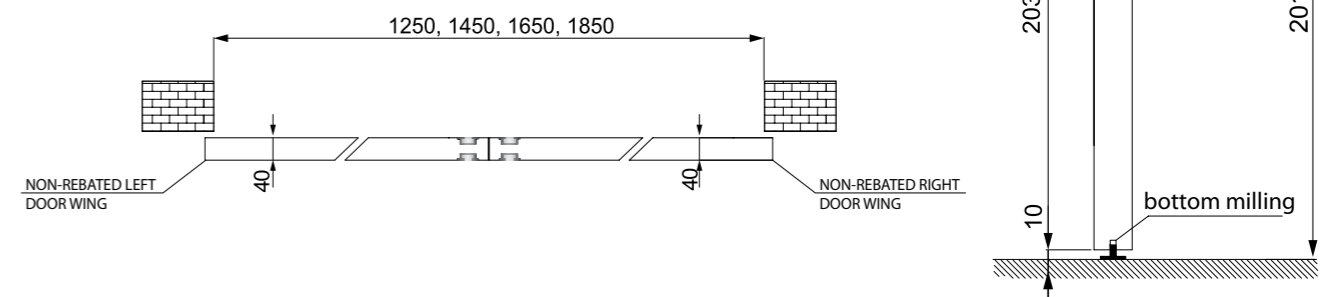

Steel round holder
colour: silver, graphite



Steel oval holder
colour: silver, graphite



Hook lock
+ rosette

* oval holder does not feature installing hook lock

SYSTEM LOFT GLASS

NEW

SLIDING
SYSTEM



VOSTER®



TRANSPARENT GLASS GRAPHITE 80, 90

TRANSPARENT GLASS WHITE 80, 90



LOFT PURE GLASS system that combines a high level of aesthetics and functionality, intended for glass sliding doors, interior.

The use of the **LOFT PURE GLASS** system will not only visually enlarge space, but also emphasise the unique, modern and elegant character of the interior, full of sunlight and space.

Advantages of the system:

- the possibility of using a glass pane in various finishes, thanks to which we can emphasise the individual character of the room, its discreet separation or integration with the entire interior design
- the system provides illumination of the space and its optical enlargement
- colour of fittings in line with the latest interior decoration trends
- the use of the Loft Pure Glass system gives the interior lightness, elegance and a modern character

Max. door weight 70 kg

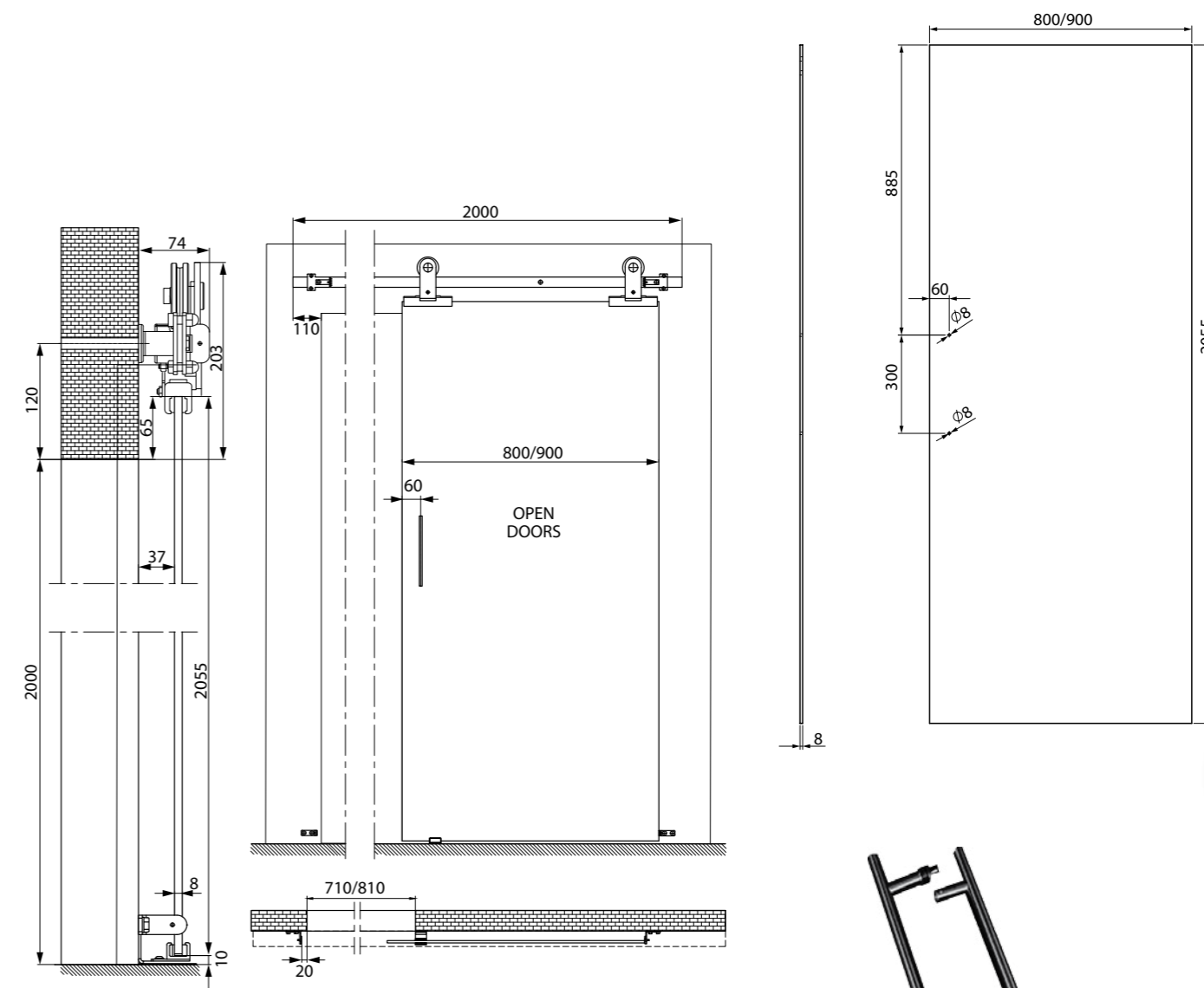

HOLDER

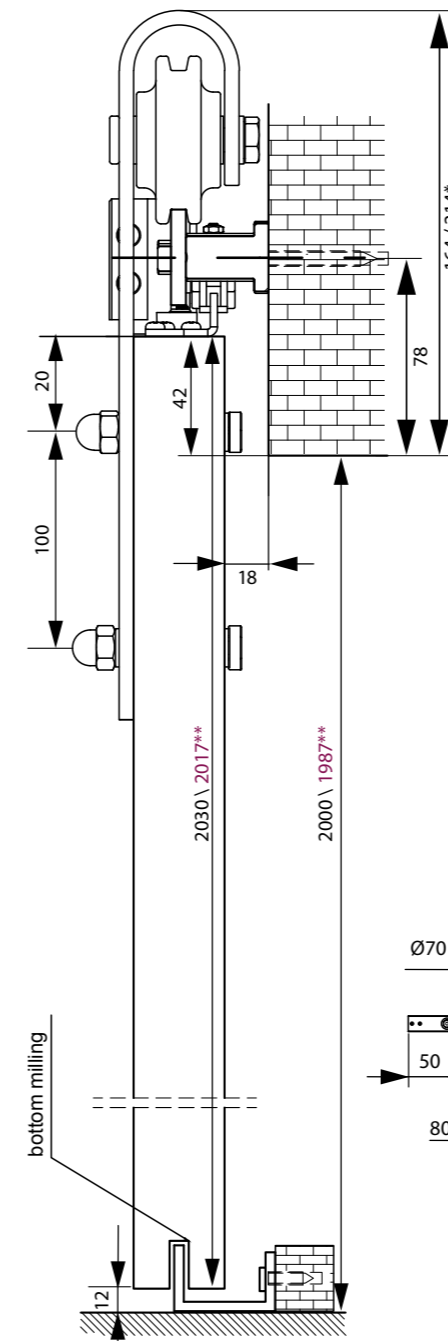

LOFT LINE



LOFT LINE XL

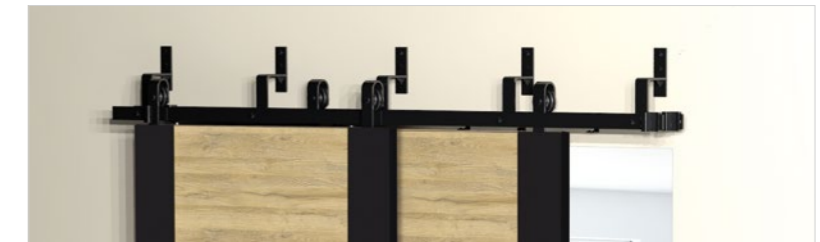

double system

The collections of LOFT LINE systems are the systems inspired by the loft aesthetics - vintage. The visible mechanical elements of the system together with dark lacquer coating add the interior unique character. The system does not feature Windsor and Mono door wings.

Advantages of the system:

- Silent and smooth rail thanks to bearing rolls
- Easy mounting, door wing can be fixed in desired position
- Lacquer coating on the rail and all system elements is characterised by high resistance to mechanical impact, and also it prevents from dust accumulation.

Accessories charged additionally:

- **Door closer**
- **Mortise door wing holder**
- **External holder**
- **On-wall bottom rail**, assembly does not require to make drills in the floor
- **Wall clamp** to loft line double system mount
- **Rail clamp**

Sliding system **LOFT LINE**
Sliding system **LOFT LINE XL**
Double Sliding system **LOFT LINE**
Double Sliding system **LOFT LINE XL**

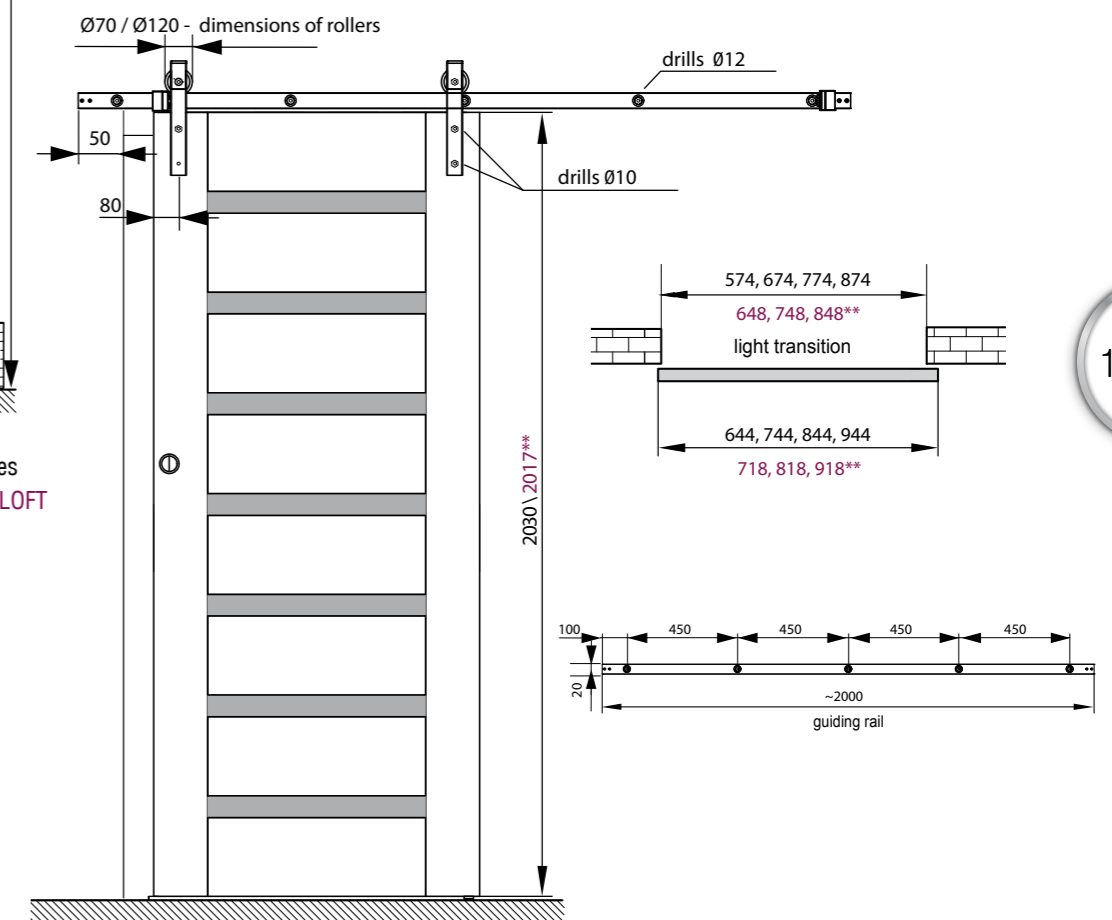
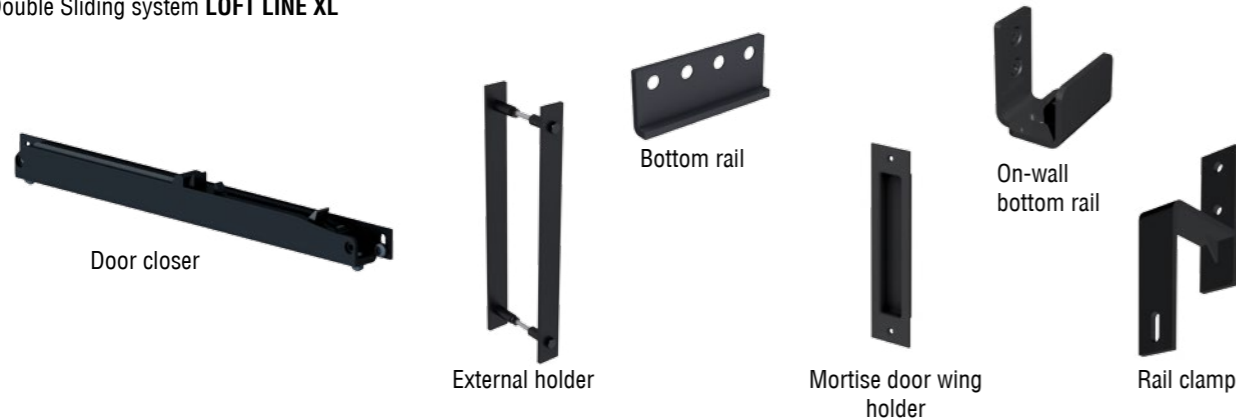

* roller is available in two sizes
** applicable to door wings: LOFT

MAX. DOOR WEIGHT 100 KG MAX
DOOR WING WIDTH 945 MM RAIL
LENGTH 2000 MM
COATING COLOUR: BLACK MATT

ALUMINIUM ON-WALL SLIDING SYSTEM

SLIDING SYSTEM



VOSTER®

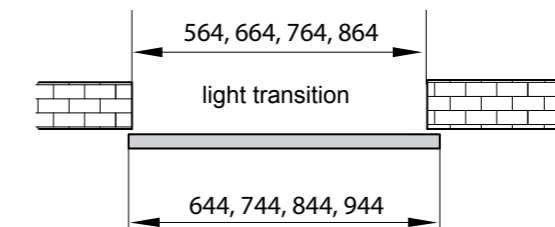
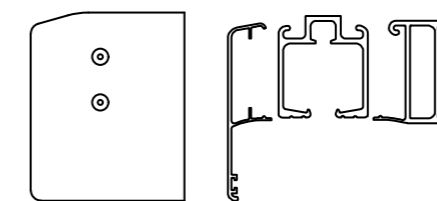
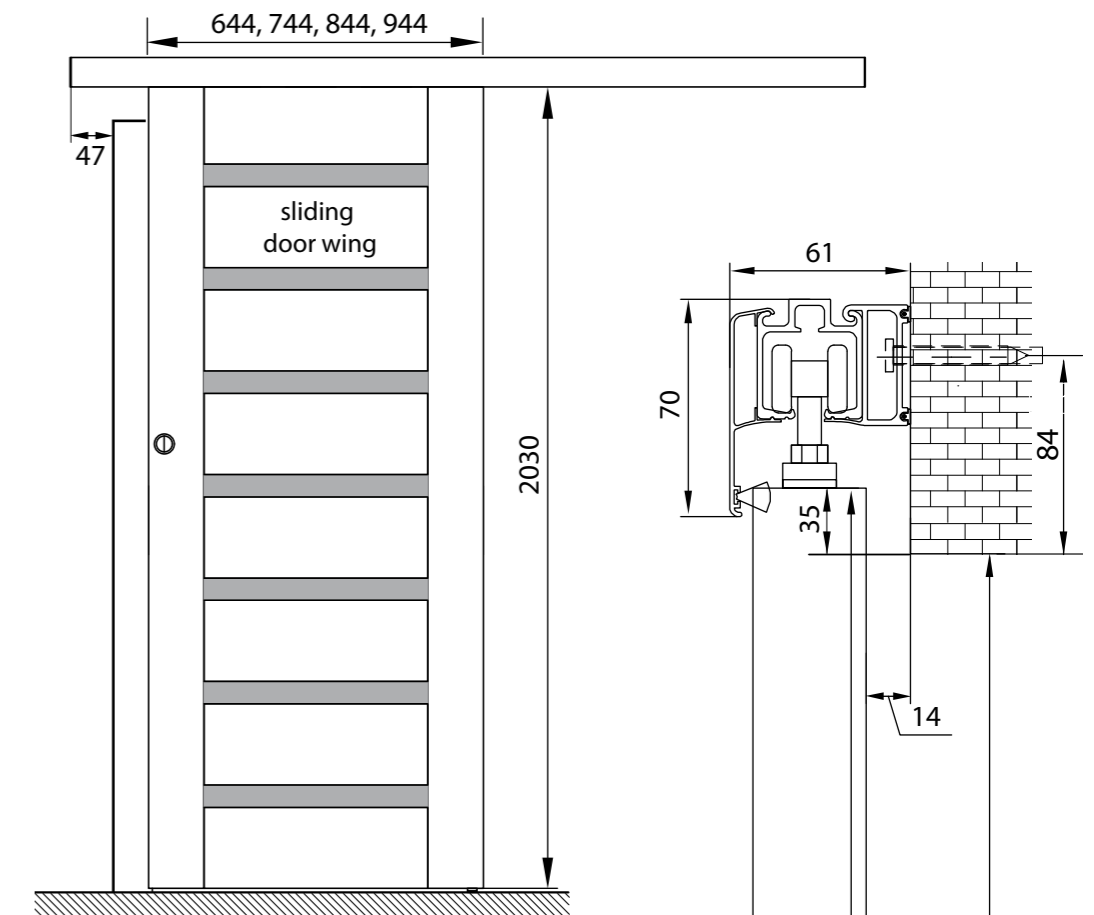

GUIDING RAIL

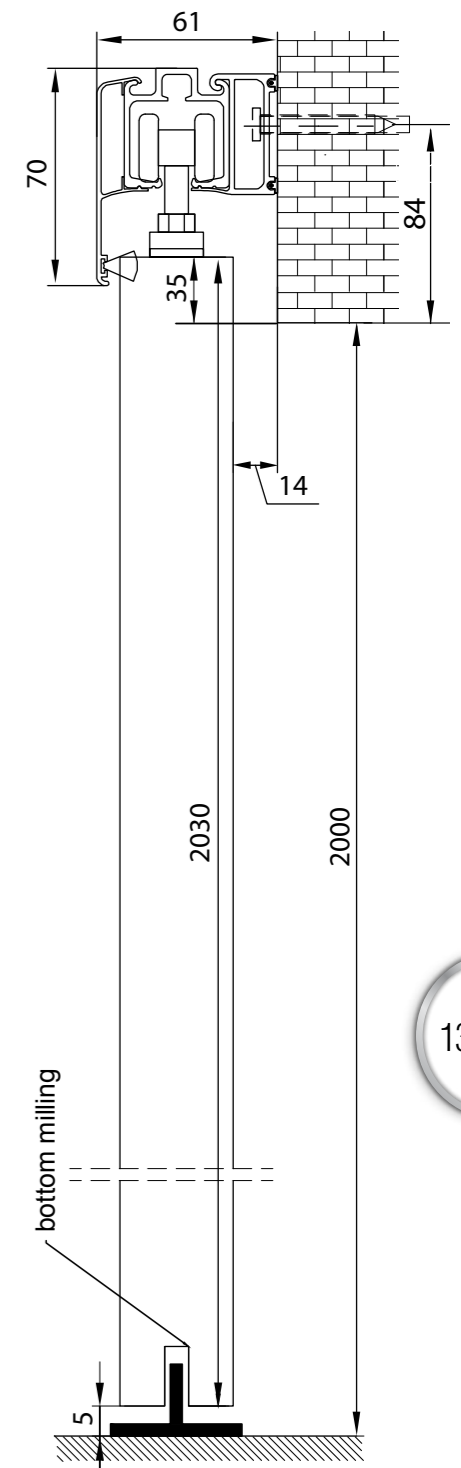
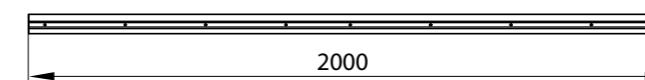

Single aluminium on-wall sliding system

The system does not feature Windsor and Mono door wings.

Description:
System dedicated to interior doors, combining elegant design, smooth lines with strong rigid rail guide construction and unique six hardware. The rail is made of high quality anode aluminium.

It features:

- Drilled mounting holes
- Construction enhancement to provide stability and muting system operation
- 'Click' system that enables fast and easy masking trim mounting as well as on-wall profile directly to the rail
- Simple and intuitive mounting system

Maximum working load 100 kg per one door wing

Additional charges:

- Anti-dust brush that can be used to conceal the distance between the top door wing edge and the masking trim. Brush is available in two colours - white or grey.

SLIDING SYSTEM MAGPLUS

NEW

SLIDING
SYSTEM



VOSTER®



PRESENTED DECOR: MARENGO

AVAILABLE DECORS:

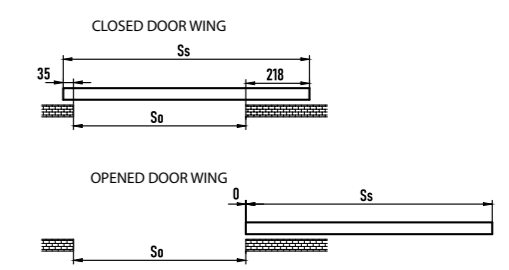
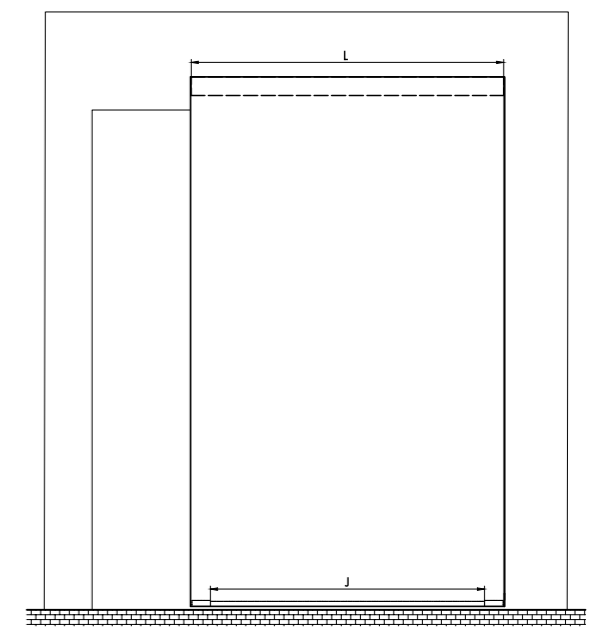
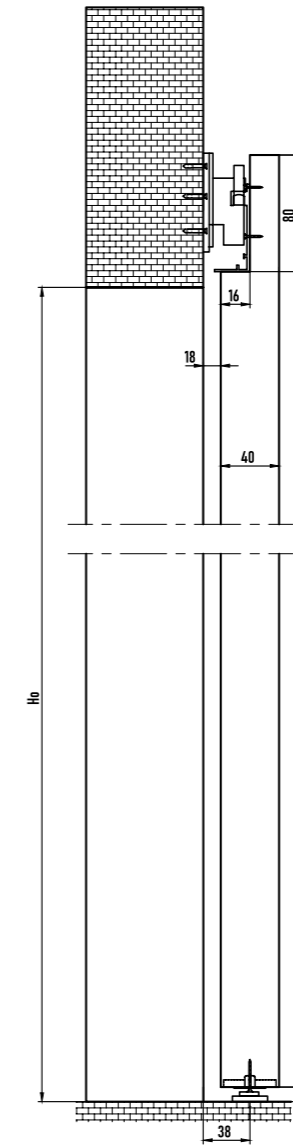

MAGPLUS system with concealed rail system

The system is available for non-rebated panel door wings MAG type.

MAGPLUS sliding system contains micrometric adjustment system that enables vertical and horizontal adjustment, to compensate for any unevenness in the walls.

To increase the smoothness of movement, the system is equipped with a metal bottom rail.

MAGPLUS SYSTEM

DOOR WING + STEEL OVAL HOLDER



FILLING – SOLID BOARD

BRASS VENTILATION SLEEVES

Indication	Description	Width		
		80	90	100
Ss	Width of door wing	844	944	1044
So	Wall opening width	590	690	790
Hs	Height of door wing	2100	2100	2100
Ho	Wall opening height	2000	2000	2000
L*	Upper profile system length	841	941	1041
J*	Bottom profile length	671	771	871

NON-REBATED V-RETTO DOOR FRAME

DOOR FRAMES



AVAILABLE DECORS:



FINISHING – VENEERED DOOR WING:
 ● – FINISH FOIL, ● – 3D VENEER,
 ● – CPL LAMINATE, ● – PP PLATINIUM

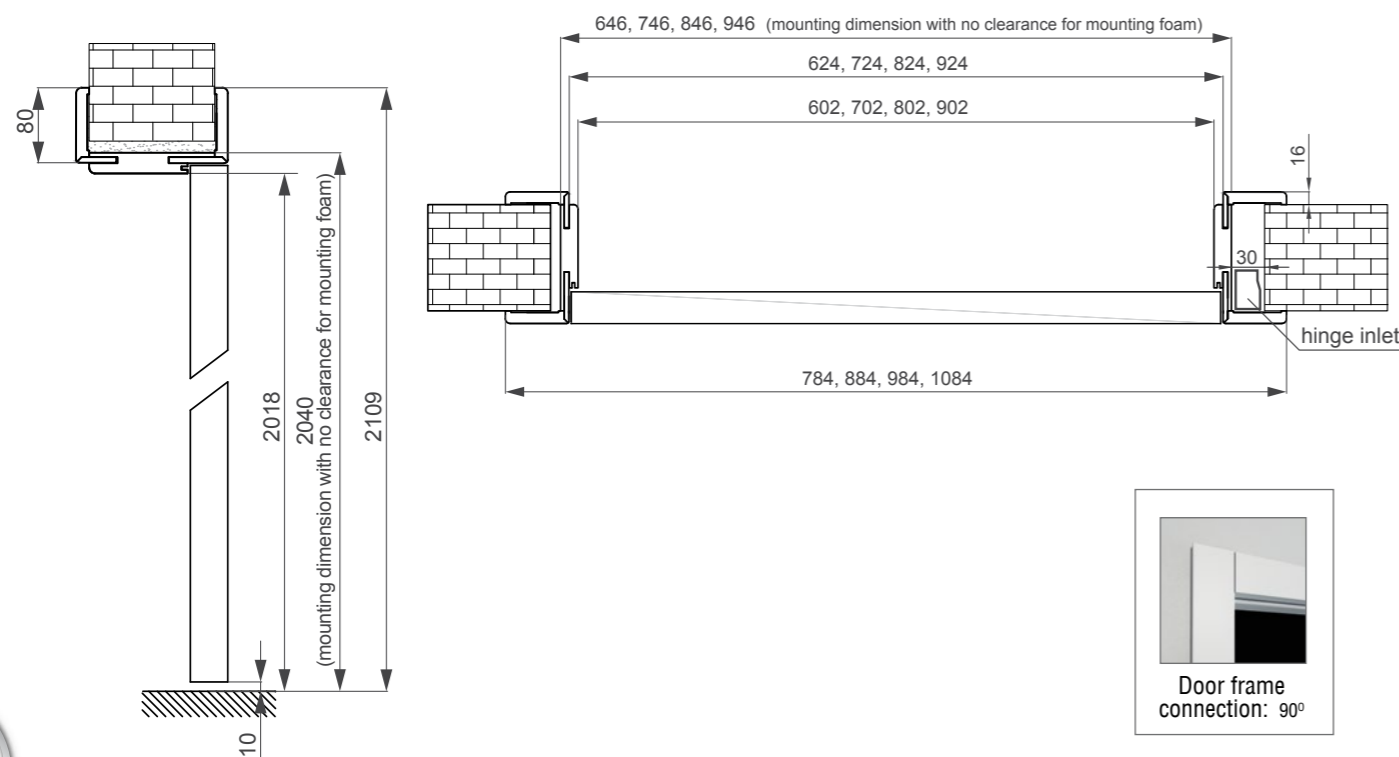

Door frame connection: 90°

ADJUSTMENT RANGE

- FF ● 3D
- CPL ● PP

80-100
100-140
140-180
180-220
220-260
260-300
300-340
340-380
380-420
420-460

V-Retto = door frame connection + door frame band 80 mm

Connection ranges of non-rebated adjustable V-Retto door frames ● FF, ● 3D, ● CPL, ● PP

One-element door frames: 80-100 to 300-340

Two-element door frames: 340-380 to 420-460

- Door frames of following widths: 60 – 100
- Door frame band width – 80 mm
- Additional charge: Door frames to double doors price + 50%, does not feature collections MAGNETIC and LOFT.
- Tunnel mounting = V-Retto Standard door frame page 142
- Third hinge

Door frames above the range 460 mm are available at individual inquiry.

NON-REBATED FIXED DOOR FRAME

DOOR FRAMES



AVAILABLE DECORS:



FINISHING – VENEERED DOOR WING:
 ● – FINISH FOIL, ● – 3D VENEER,
 ● – CPL LAMINATE, ● – PP PLATINIUM

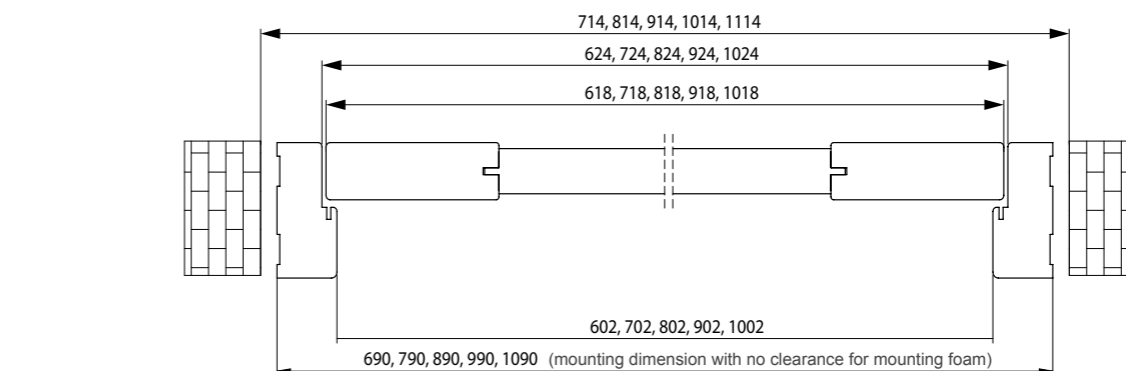

Door frame connection: 90°

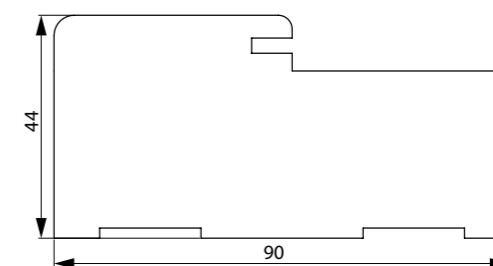
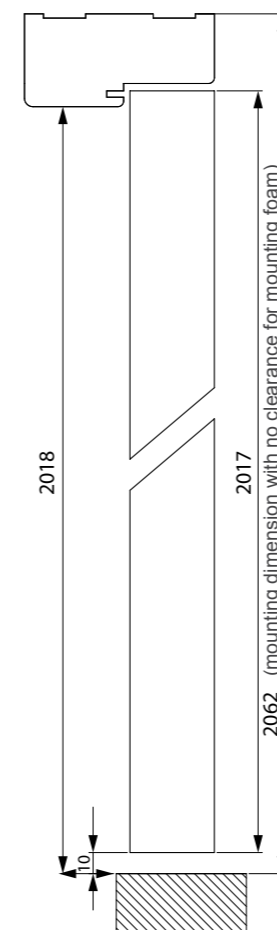

NON-REBATED FIXED DOOR FRAME

- FF, ● 3D, ● CPL, ● PP

Base left, right
Upper beam 60-100
Base to double doors
Beam to double doors
Masking trim 60x8x5500 mm
Masking trim 70x12x5500 mm
Quarter round 18x18 mm
Masking trim 60x8 mm to double doors
Masking trim 70x12 mm to double doors
Quarter round 18x18 mm to double doors

Third hinge – extra charged

REBATED ADJUSTABLE DOOR FRAME V-RETTO STANDARD

DOOR FRAMES

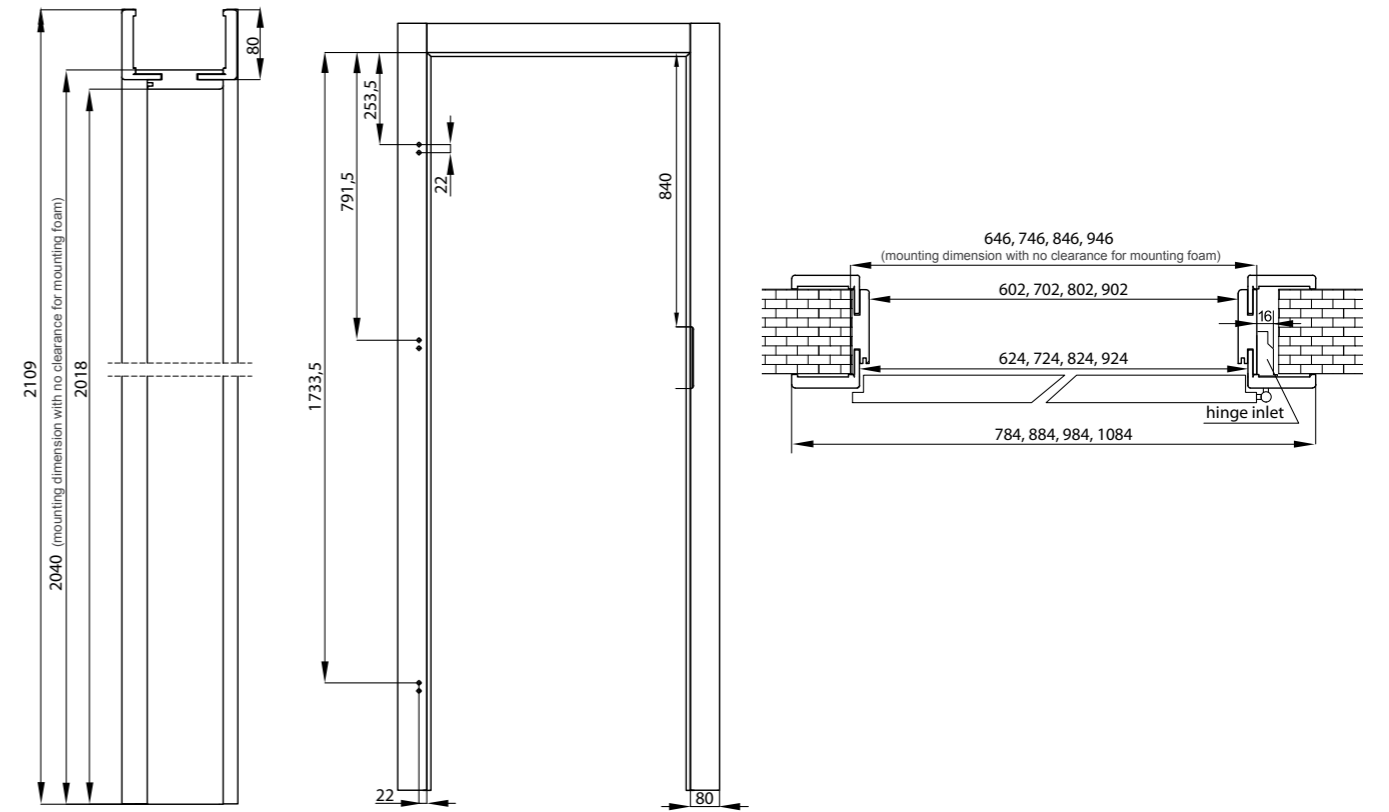
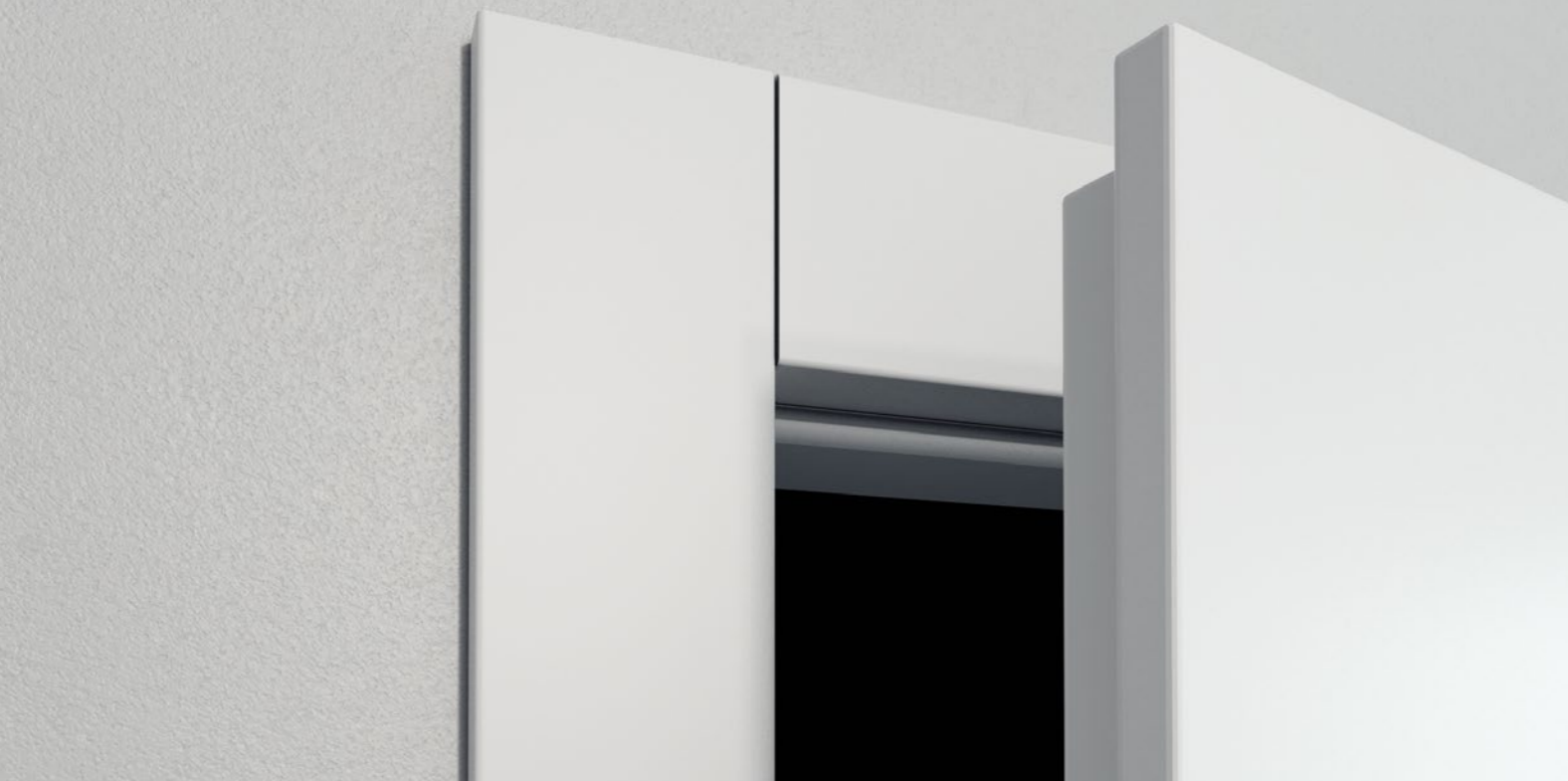

AVAILABLE DECORS:



ADJUSTMENT RANGE

● FF ● 3D ● CPL ● PP

80-100
100-140
140-180
180-220
220-260
260-300
300-340
340-380
380-420
420-460

Additional charge: door frame to PLATO wing

Ranges of V-Retto adjustable rebated coro frame connections:

● FF, ● 3D, ● CPL, ● PP

One-element door frames: 80-100 to 300-340

Two-element door frames: 340-380 to 420-460

- Width of door frame masking band – 80 mm
- Additional charge: Door frame to double doors + 30% of door frame price
- V-Retto = door frame connection at angle 90+masking band 80 mm

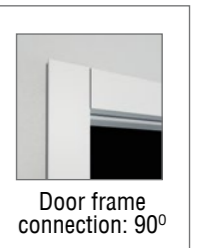

ADJUSTABLE STANDARD DOOR FRAME

DOOR FRAMES



AVAILABLE DECORS:



ADJUSTABLE DIN DOOR FRAMES - SQUARE 60x45 mm

ADJUSTMENT RANGE

● FF ● 3D ● CPL ● PP

60-80
80-100
100-120
120-140
140-160
160-180
180-200
200-220
220-240
240-260
260-280
280-300
300-320
320-340
340-360
360-380
380-400
400-420

Additional charge: door frames to PLATO door wings

ADJUSTABLE DIN DOOR FRAMES - SQUARE 80x65 mm

ADJUSTMENT RANGE

● FF ● 3D ● CPL ● PP

80-100*
100-140
140-180
180-220
220-260
260-300
300-340
340-380
380-420

*SQUARES 80x45 mm

SQUARES - BAND WIDTH 60 mm

- square to adjustable door frame 3D FF 60x45 mm lub 60x65 mm
- square to adjustable door frame CPL 60x45 mm lub 60x65 mm
- square to adjustable door frame V-PLATINIUM 60x45 mm lub 60x65 mm

SQUARES - BAND WIDTH 80 mm

- square to adjustable door frame 3D FF 80x45 mm lub 80x65 mm
- square to adjustable door frame CPL 80x45 mm lub 80x65 mm
- square to adjustable door frame V-PLATINIUM 80x45 mm lub 80x65 mm

Square is the product to be ordered only as the separate item.



- Additional charge: Door frame to double doors +30% door frame price
- Door frame to glass doors - there is a difference to standard adjustable door frames
- Price of tunnel frame = price of adjustable frame.
- Door frame to glass doors - there is a difference to standard adjustable door frames
- type of door frame must be considered when ordering.

Connection ranges of adjustable door frames:

- FF, ● 3D, ● CPL, ● PP
- One-element door frames: 80-100 to 300-320
- Two-element door frames: 320-340 to 400-420

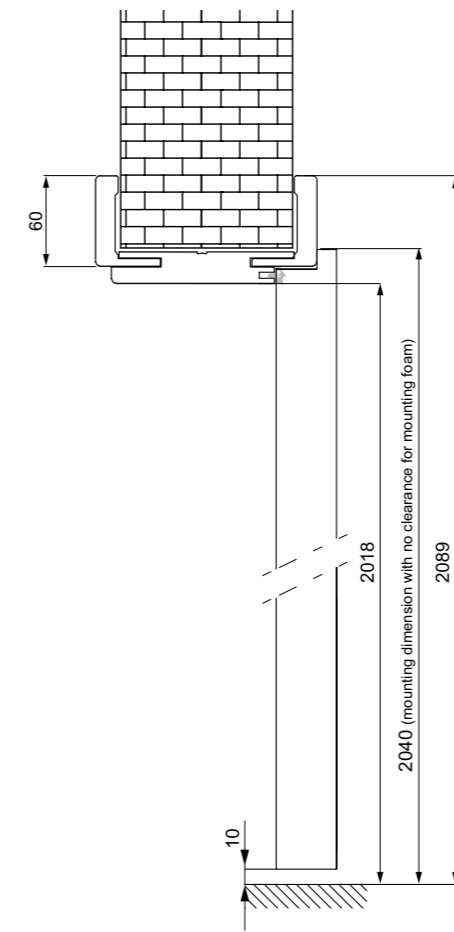

A COLOUR DIFFERENCE MAY OCCUR BETWEEN THE REBATE AND DOOR WING BOARD

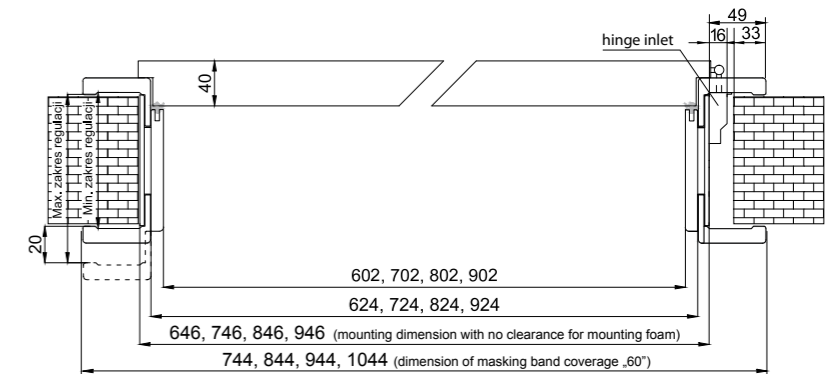
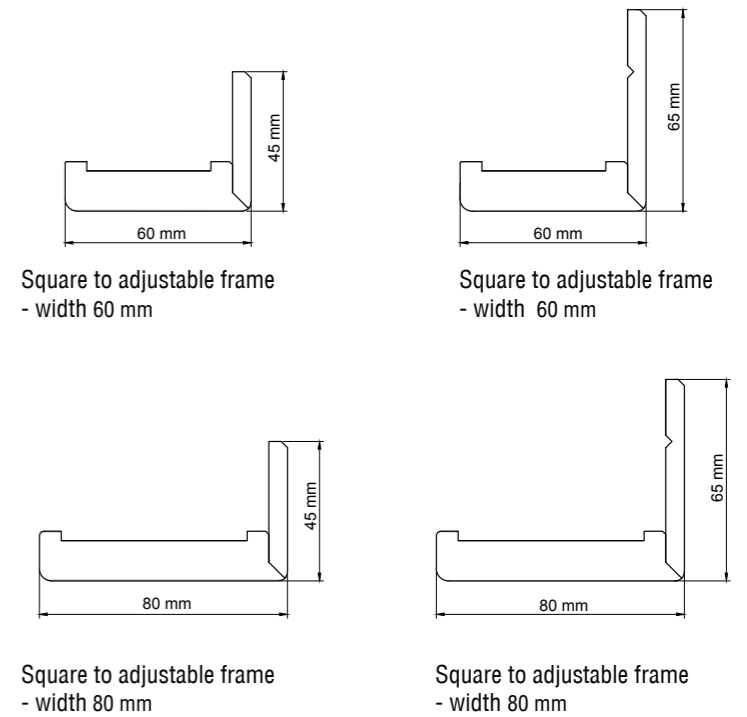

CASING FRAME TO MOUNTING OF STEEL DOOR FRAME

DOOR FRAMES

FIXED DOOR FRAME

DOOR FRAMES

AVAILABLE DECORS:



* decors available while stocks last



Connection ranges of casing door frame:

● FF, ● 3D, ● CPL, ● PP
 One-element door frames: 80-100 do 260-280
 Two-element door frames: 280-300 do 400-420

CASING DOOR FRAME

● FF, ● 3D, ● CPL, ● PP

- To mounting of steel door frame 80 mm set (80-100)
- To mounting of steel door frame 100 mm set (100-120)
- To mounting of steel door frame 120 mm set (120-140)
- To mounting of steel door frame 140 mm set (140-160)
- To mounting of steel door frame 160 mm set (160-180)
- To mounting of steel door frame 180 mm set (180-200)
- To mounting of steel door frame 200 mm set (200-220)
- To mounting of steel door frame 220 mm set (220-240)
- To mounting of steel door frame 240 mm set (240-260)
- To mounting of steel door frame 260 mm set (260-280)
- To mounting of steel door frame 280 mm set (280-300)
- To mounting of steel door frame 300 mm set (300-320)
- To mounting of steel door frame 320 mm set (320-340)
- To mounting of steel door frame 340 mm set (340-360)
- To mounting of steel door frame 360 mm set (360-380)
- To mounting of steel door frame 380 mm set (380-400)
- To mounting of steel door frame 400 mm set (400-420)

Door frames above the range 420 mm are available at individual inquiry.

AVAILABLE DECORS:

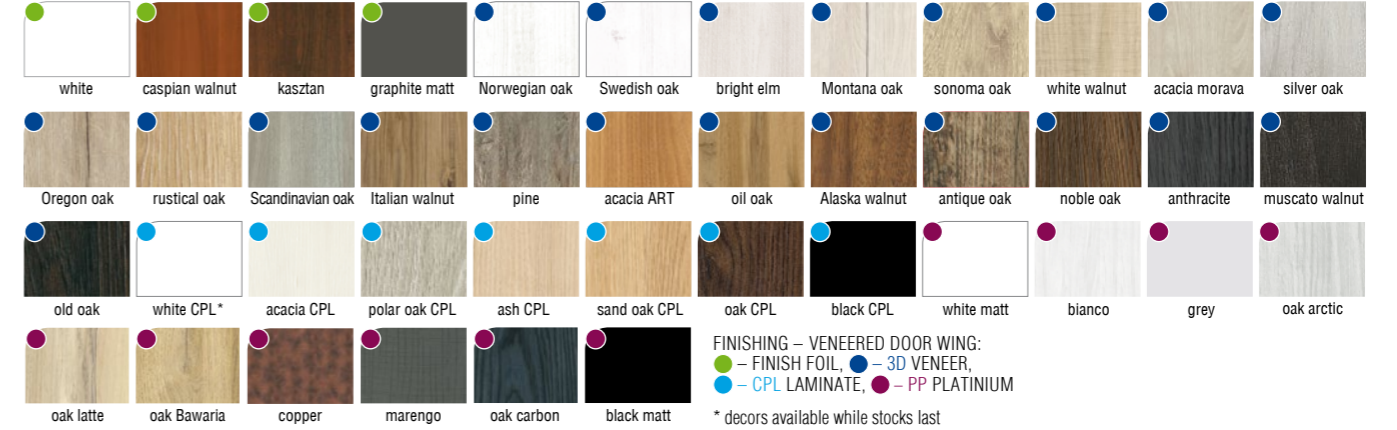

* decors available while stocks last

FIXED DOOR FRAME

● FF, ● 3D, ● CPL, ● PP

- Base left, right
- Enhanced base (inlets)
- Enhanced base (inlets) Plato door wing
- Upper beam 60-100
- Base to double doors door frame
- Enhanced base (inlets) to double door frames
- Upper beam to double doors
- Masking trim 60x8x5500 mm
- Masking trim 70x12x5500 mm
- Masking trim to double doors 60x8 mm
- Masking trim 70x12 mm to double door frames
- Quarter round 18x18 mm
- Quarter round 18x18 mm to double door frames

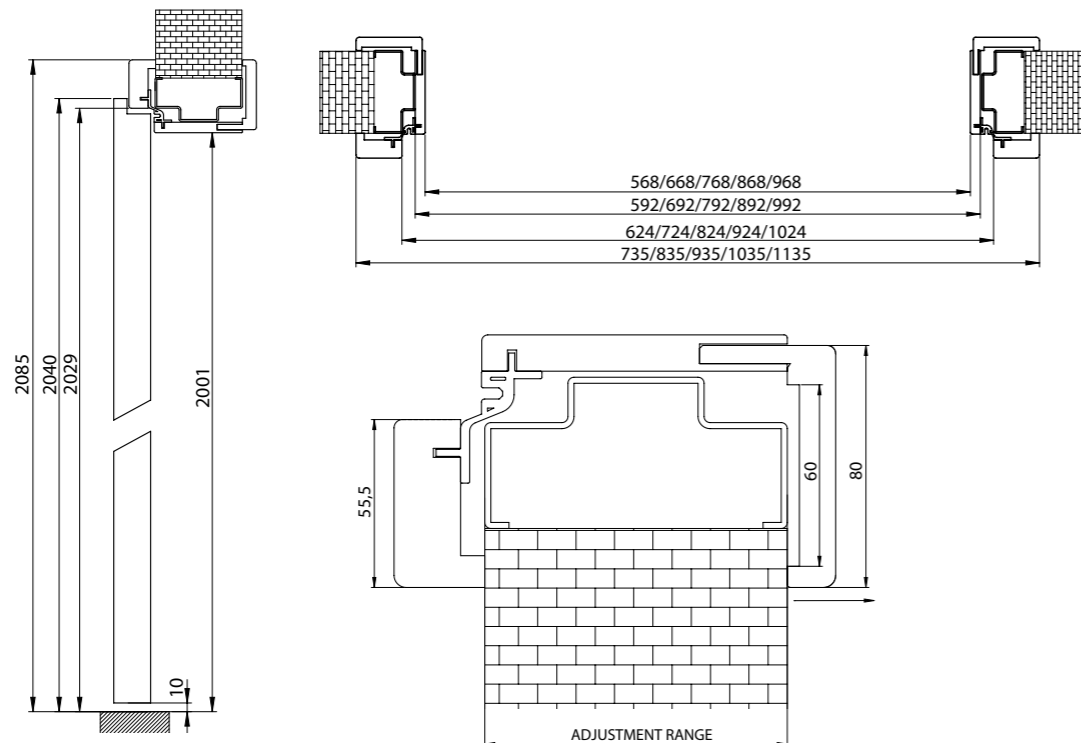
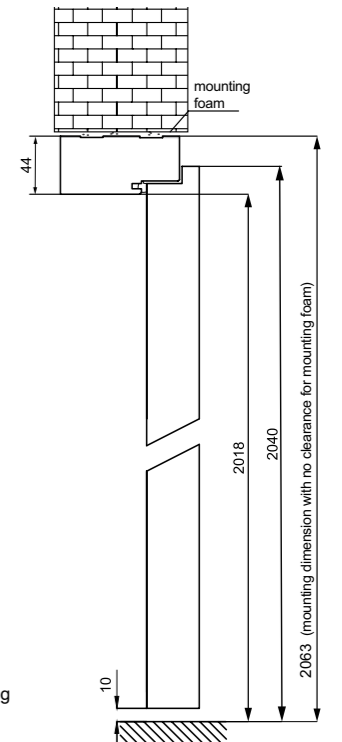
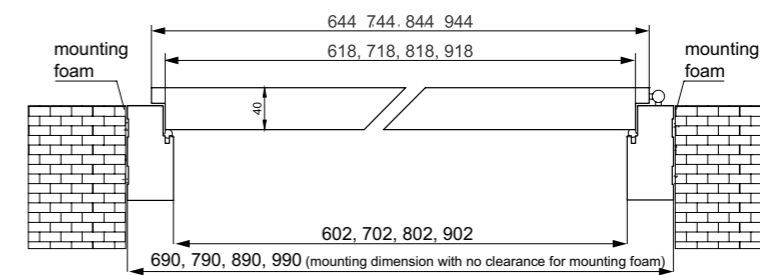
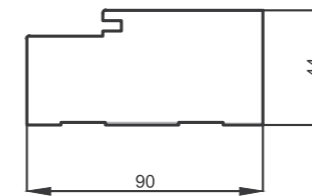

Black hinges are available only with enhanced door frame with insets



TOPS

TO V-RETTO ADJUSTABLE DOOR FRAMES



DOOR FRAMES



TOPS

TO ADJUSTABLE DOOR FRAMES



VOSTER®

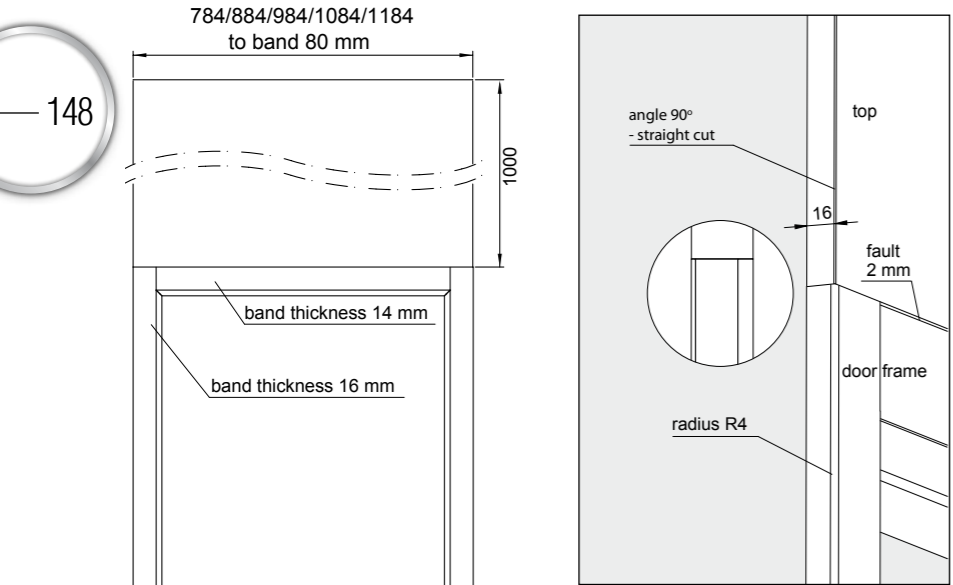

- AVAILABLE DECORS:
- | | | | |
|--|--|--|--|
| | | | |
| | | | |
| | | | |
| | | | |
| | | | |

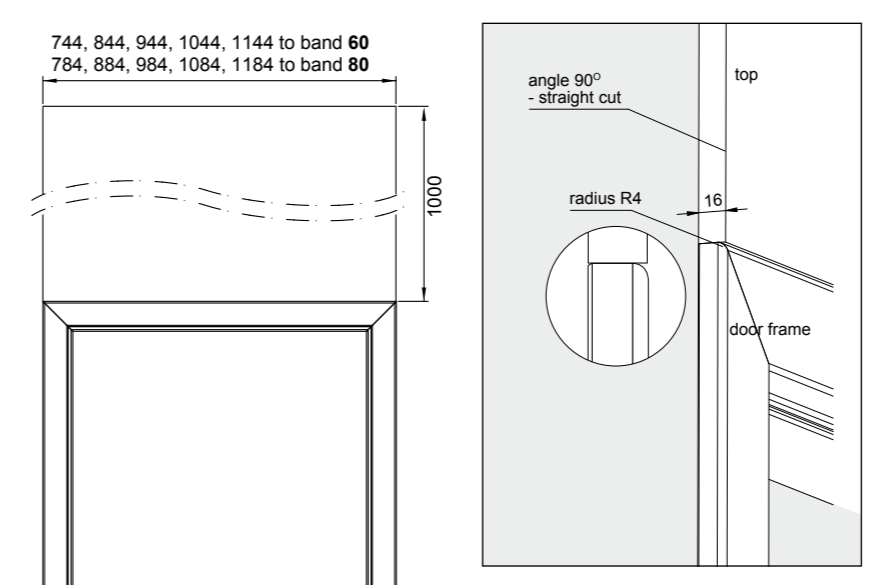

- AVAILABLE DECORS:
- | | | | |
|--|--|--|--|
| | | | |
| | | | |
| | | | |
| | | | |
| | | | |
| | | | |

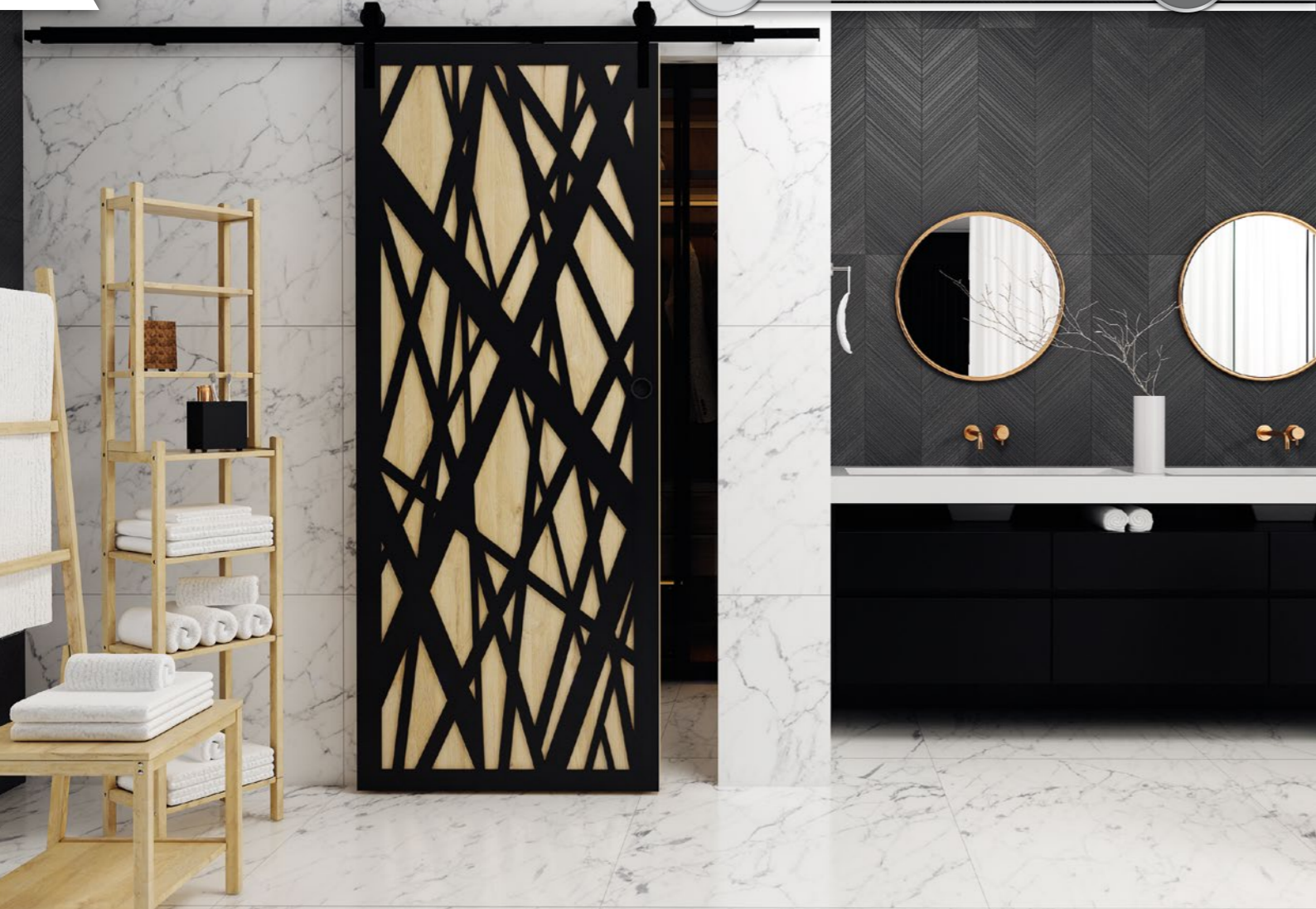

OPENWORK TO SLIDING DOOR WINGS

Openwork – decorative panel made of steel 0.7 mm painted RAL 9005.

It is glued by default on the door wing surface. It is dedicated to non-rebated full plain door wings in sliding system. It does not feature full plain HDF varnished plain door wings.

Available width in Polish norm 80, 90, 100.

Additional charge:
Round steel holder



BAND 100 ADJ



dedicated to standard adjustable door frame with square 60x45 mm

AVAILABLE DECORS:

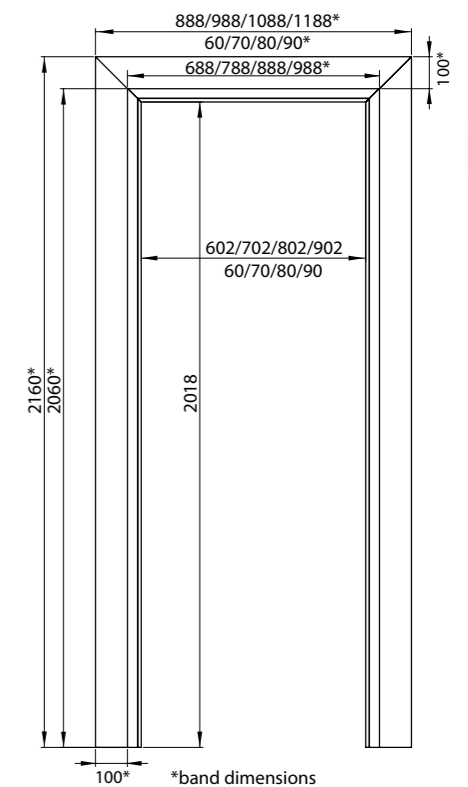
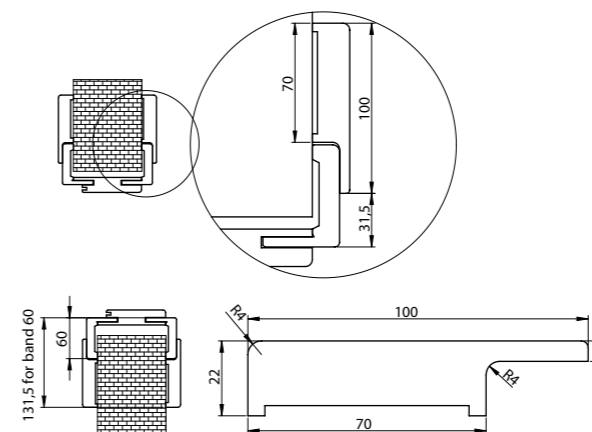

PROTECTIVE PANEL



PROTECTIVE PANEL



PROTECTIVE PANEL INOX CENTRE (two sides)



PROTECTIVE PANEL INOX VENTILATION (two sides)



Protective bottom panel with ventilation, dimension for width 80

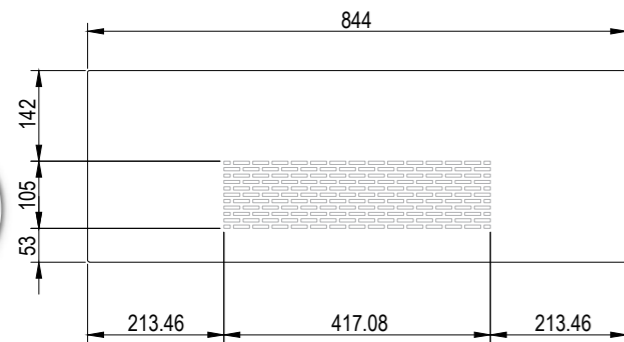

Steel ventilation grill

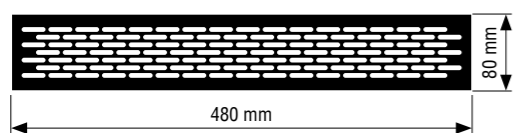

available colours:



Protective central panel with drilling for lock bathroom/key/cylinder

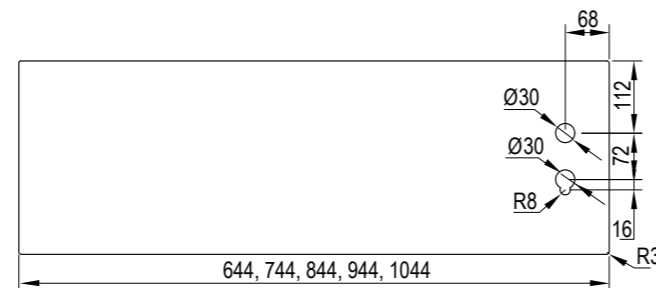

Protective central panel with drilling for economy lock

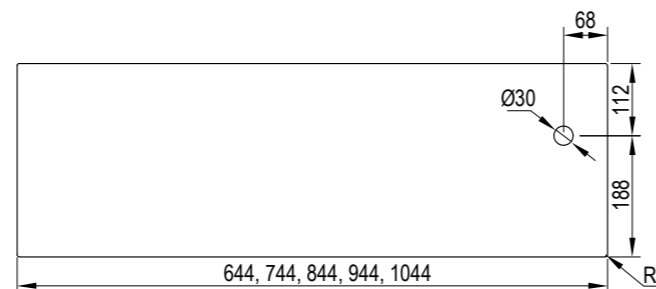

FLOOR MOULDING TRIM

AVAILABLE DECORS:

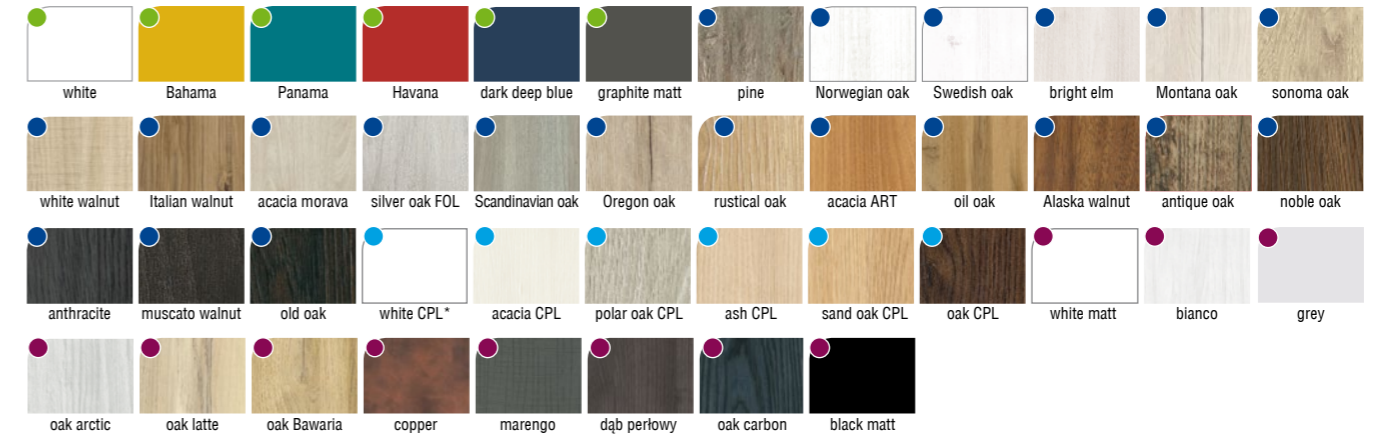

* decors available while stocks last

Trims are packed 5 pcs a set, length 2050 mm. Trims are sold only in a set.

● FF, ● 3D
● CPL ● PP

FLOOR MOULDING TRIM
80x16x2050 mm

ADDITIONALLY CHARGED OPTIONS:
- MOUNTING BUCKLES FOR FLOOR MOULDING TRIM 1 SET (30 PCS)

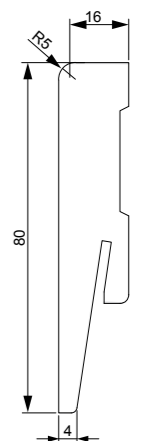

DECORATIVE PROFILES: LAMELLAS



Lamella – a decorative element used to decorate both walls and ceilings.

The lamella consists of two elements: a mounting strip, which is mounted directly on the wall or ceiling with mounting glue or screws, and a U profile covered with decorative foil, which is mounted on the mounting strip.

Lamella is made of MDF and is veneered: ● FF, ● 3D, ● CPL, ● PP

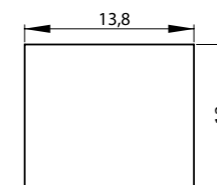

MOUNTING PROFILE

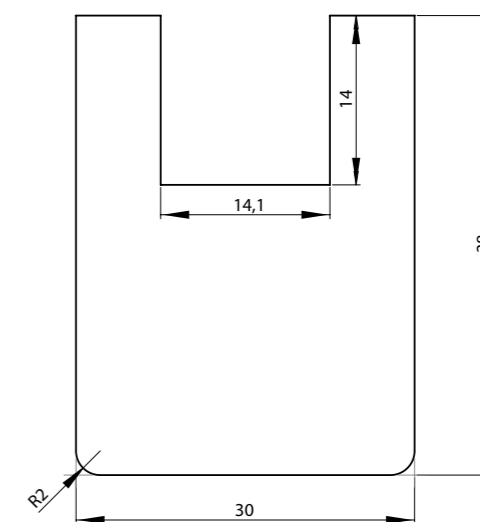

DECORATIVE PROFILES (length 2800)

● FF, ● 3D, ● CPL, ● PP

Lamellas are packed 4 pcs. in a set. Length 2800 mm.

Package weight 14 kg.

Lamellas are sold only in a set.

Due to non-standard dimensions of the package (length over 2800 mm) in some cases an additional transportation cost must be added:

- weight to 30 kg (1-2 sets)

- weight to 500 kg

Additional transportation cost should be consulted with the sales point.

Rimless LAMELLAS – to individual cutting.

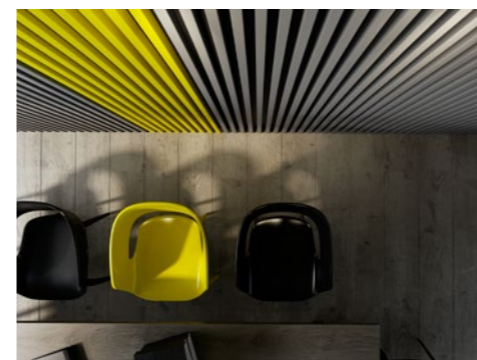

AVAILABLE DECORS:



PRESENTED DECOR: SAND OAK CPL

INTERIOR DOOR HANDLES

PLATINIUM

R8 ONE
DIRECTION DOOR HANDLES LEFT, RIGHT



Colours: velvet grey



Colours: kaschmirgrau



Colours: graphite black



3D



Colours: black, chrome satin, chrome polished



ROSETTE, KEY, CYLINDER OR BATHROOM ROSETTE
Colours: black, chrome satin, chrome polished



CHROME POLISHED



CHROME SATIN



BLACK

ADELA-QRS SLIM



Colours: black, chrome satin,

ELENA-QRS SLIM



Colours: black, chrome, satin nickel, white

DENVER-QRS SLIM



Colours: black, chrome, satin nickel, white



ROSETTE QRS SLIM, KEY, CYLINDER
BATHROOM ROSETTE
Colours: black, chrome, satin nickel, white

DOOR HANDLES AND ROSETTES QRS SLIM

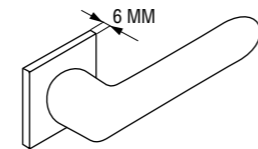

BLACK

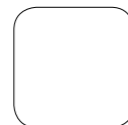

WHITE



CHROME



SATIN NICKEL

INTERIOR DOOR HANDLES

FOKUS-QR



Colours: black, nickel satin velvet, chrome polished

PRESTO-QR



Colours: chrome lacquered/nickel lacquered

TIME-QR



Colours: bronze grafiatto, chrome lacquered, nickel lacquered

JARO-QR ECO



Colours: chrome lacquered/nickel lacquered

INSIGNIA-QR



Colours: chrome lacquered/nickel lacquered

PALERMO-QR



Colours: nickel lacquered

JANE-QR



Colours: chrome lacquered/nickel lacquered

TIPO-QR



Colours: black, nickel lacquered

AXE-QR



Colours: black/white

ROMANA-R



Colours: bronze grafiatto, chrome lacquered/nickel lacquered

JARO-R ECO



Colours: chrome lacquered/nickel lacquered

TIPO-R



Colours: bronze grafiatto, nickel lacquered



ROSETTE, KEY, CYLINDER
BATHROOM ROSETTE
Colours: chrome lacquered, nickel lacquered, nickel satin velvet, titan, bronze grafiatto, chrome lacquered/nickel lacquered, black



ROSETTE, KEY, CYLINDER
BATHROOM ROSETTE
Colours: bronze grafiatto, chrome lacquered/nickel lacquered, chrome lacquered/white



CHROME LACQUERED



CHROME LACQUERED/NICKEL LACQUERED



CHROME LACQUERED/WHITE



NICKEL SATIN



CHROME LACQUERED/BLACK

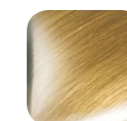

BRONZE GRAFIATTO



NICKEL LACQUERED



NICKEL SATIN VELVET



TITAN



BLACK

INTERIOR DOOR HANDLES

QUBIK-QR



Colours: chrome lacquered, nickel lacquered, nickel satin velvet, titan, black



ROSETTE, KEY, CYLINDER BATHROOM ROSETTE
Colours: chrome lacquered, nickel lacquered, nickel satin velvet, titan, bronze grafiatto, chrome lacquered/nickel lacquered, black

NEMO-QR



Colours: nickel lacquered

ERIS-QR



Colours: chrome lacquered/nickel lacquered

TIK-QR



Colours: chrome lacquered/anthracite, chrome lacquered/nickel lacquered

MILO-QR



Colours: chrome lacquered/nickel lacquered

ENE-QR



Colours: chrome lacquered/nickel lacquered



ROSETTE KW-QR, KEY, CYLINDER ROSETTE KW-QR WC
Colours: chrome lacquered/nickel lacquered

SIGMA-QR



Colours: stainless steel



ROSETTE SN04, KEY, CYLINDER BATHROOM ROSETTE SN04
Colours: stainless steel

MAFF-QR



Colours: chrome lacquered/anthracite, chrome lacquered/nickel lacquered



ROSETTE QUANTA-QR, KEY, CYLINDER BATHROOM ROSETTE QUANTA-QR
Colours: chrome lacquered/anthracite, chrome lacquered/nickel lacquered

PRO



DOOR HANDLE CYLINDER/KEY BATHROOM LOCK
Colours: bronze grafiatto, nickel lacquered

JARO-ECO



DOOR HANDLE CYLINDER/KEY BATHROOM LOCK
Colours: chrome lacquered/nickel lacquered

REAL-ECO



DOOR HANDLE CYLINDER/KEY BATHROOM LOCK
Colours: chrome lacquered/nickel lacquered

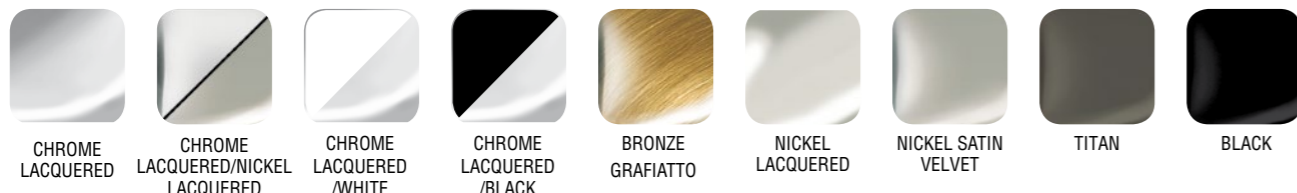

Hinge casings

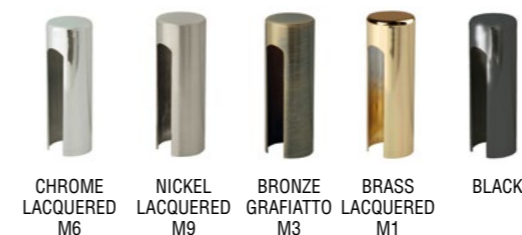

To interior door wings

Name	Colour
CYLINDER 26/36 M2	Brass
CYLINDER 26/36 M9	Nickel
CYLINDER 26/36G M2	Brass
CYLINDER 26/36G M9	Nickel

Brass ventilation sleeves

*Only framed door wings.

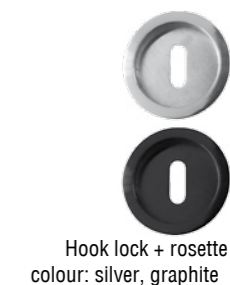

Hinge 1 pc to door wing and enhanced adjustable and fixed door frame together with inset. Not available in Czech norm and Models: Q, X, Y, V.

DOOR CLOSER

DOOR CLOSER - slows down the movement of the door wing in the final phase of its closing, aligning it gently into the frame. Increases doors exploitation safety and prevents the wing from bumping onto the door frame.

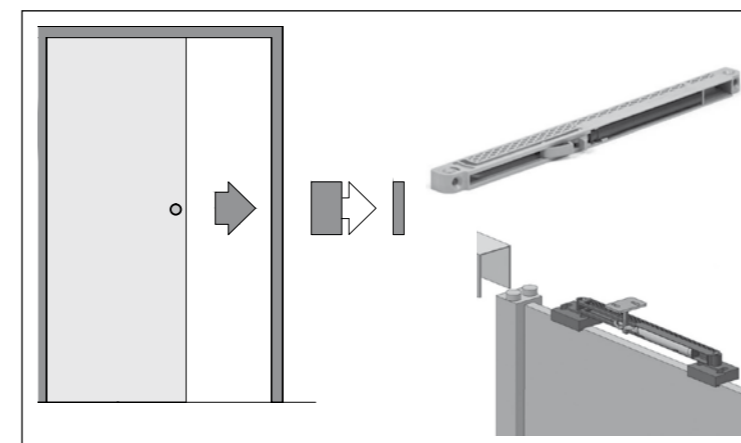

DOUBLE DOORS SYNCH SYSTEM

Synch system synchronises the movement of door wings in double door system; moving one wing causes analogous movement of the other wing.

For interior doors, excluding glass doors.

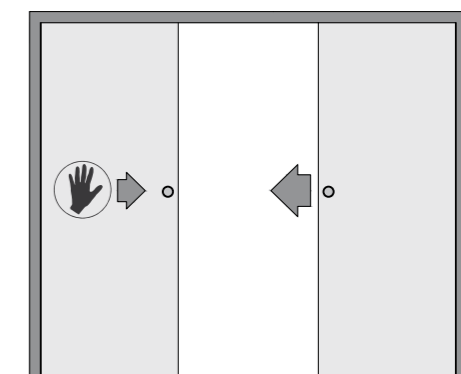

SEALS

Seal pressed to door frame interior – set. 5 linear metres



door frame colour

seal colours							
EXTRA BEIGE	BROWN GREY	WHITE	BLACK	ZINC GREY	GRAPHITE GREY	KIBI	SILVER 62
Acacia morava	Anthracite	Acacia cpl	Black	Oak arctic	Graphite matt	Acacia art.	Pine
Montana oak	Antique oak	White	Black cpl	Polar oak	Marengo		
Oil oak	Oak cpl	White cpl	Black matt	Silver oak			
Oregon oak	Old oak	Bianco	Oak carbon	Grey			
Sand oak cpl	Noble oak	White matt.	Dark deep blue				
Rustical oak	Alaska walnut	Bright oak					
Scandinavian oak	Caspian walnut	Norwegian oak					
Sonoma oak	Muscato walnut	Swedish oak					
Oak latte	Nevada walnut	Bright elm					
Oak bawaria	Copper						
Ash cpl							
White walnut							
Italian walnut							

RED	BLUE	YELLOW
Havana	Panama	Bahama

MASKING TRIMS



Masking trim
60x8x5500 mm, 5,5 lm
● FF, ● 3D ● CPL ● PP

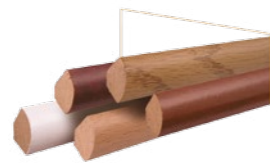

Masking quarter round
● FF, ● 3D ● CPL ● PP

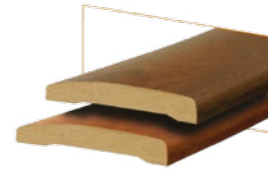

Masking trim soft
70x12x5500 mm, 5,5 lm
● FF, ● 3D ● CPL ● PP

1 set for one side of door frame

ELECTRIC STRIKE

Available types of electric strikes 12 V:

- 410-12AC/DC (closed, supplying power causes opening)
- 1411-12DC (open, supplying power causes closing)
- 1420-12AC/DC (with the switch, closed, supplying power causes opening, can be switched off manually by moving the lock latch)

Electric strike is available to following door frames:

- electric strike is available to following door frames: page. 142-143
- adjustable standard page 144-145
- fixed page 147



AUTOMATIC THRESHOLD



Door wing without automatic threshold



Door wing with automatic threshold

AUTOMATIC THRESHOLD – FEATURES FRAMED AND PANEL DOOR WINGS (ENHANCED WITH SOLID BOARD)

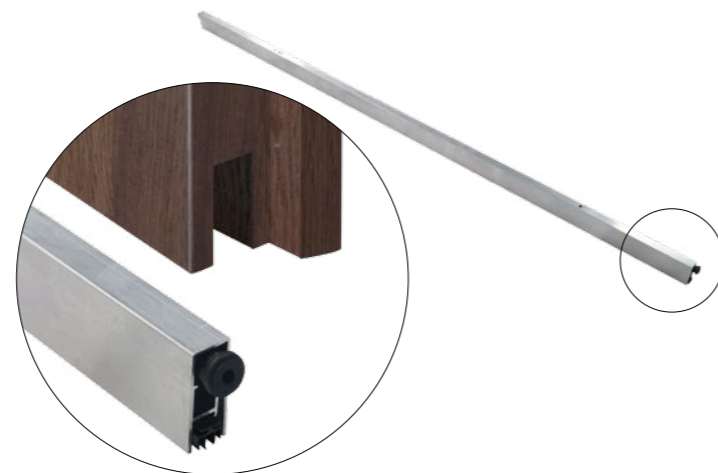

- Mounted on the bottom part of door wing
- Automatic, gradual descending with closing the wing
- Increased soundproofing
- Exact, fixed seal press that eliminates the need for standard threshold
- Simple regulation of press power

DOOR WING RIGHT

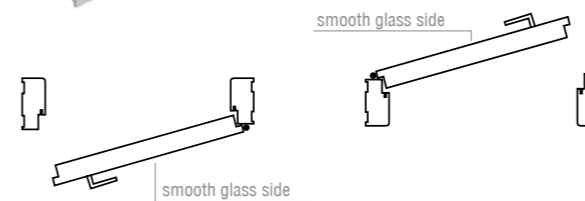

DOOR WING LEFT

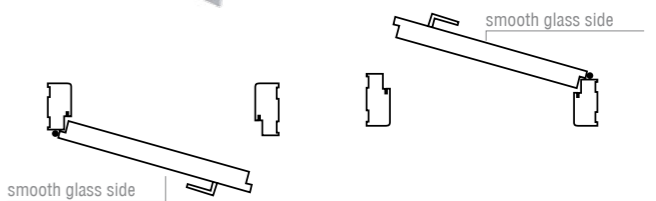

REBATED DOOR WING



NON-REBATED DOOR WINGS



REBATED SINGLE DOOR WINGS

All Voster rebated door wings match door frames accordant to Polish building norms

- Standard width of door wings: 60, 70, 80, 90.
- Width 100 – framed door wings (does not feature wings: Kubus, Lupus, Incanto, Prado, Mediolan, Bornos): additional charge
- Width 100 – panel door wing additional charge
- Lock has one turn-key option
- Due to the fact that the decorative foil with which our products are glued imitates the grain of the wood, which does not have the same grain pattern and the same colour throughout the length and width of the tree, the decorative foil in the longitudinal and transverse direction does not have the same colours and grains.
- Panel wings (honeycomb), width 100 and wings enhanced with a solid board, width 60 - 100, are equipped with three hinges as standard.

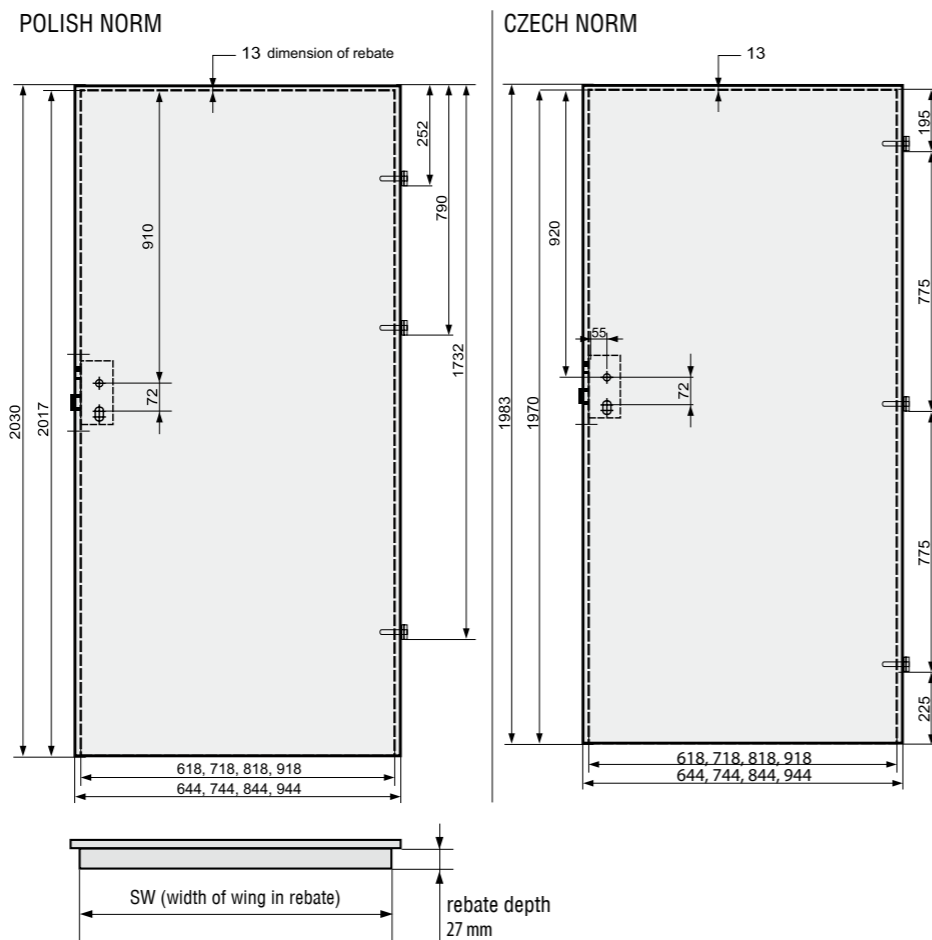

FRAMED DOOR WINGS ● FRAMED DOOR WINGS PLATINIUM COLLECTION

- solid construction
- 3 pintle hinges
- 3 regulated pintle hinges – PLATINIUM COLLECTION
- Innovative way of rail veneering: rimless
- Rail of coniferous wood – PLATINIUM COLLECTION
- Rigid, stable construction
- High endurance to mechanical impact
- No glazing beads
- Tempered glass
- Smooth side of the glass is on the wider side of the door wing.
- Glass can be fixed reversely - no additional charge.
- Lock has one turn-key option
- Possibility to independently cut the framed door wings up to 4 cm in the Polish norm and 3 cm in the Czech norm without losing the warranty - does not feature sliding door wings and double doors.

- The manufacturer reserves the possibility of differences in the translucency and coloration of the panes made in screen printing technology, compared to the panes installed in the exhibition wings or in the earlier production runs of the door wings.
- Door wing can be made without a drill for key (economy lock) – no additional charge.
- Central elements of door wings MOBI, GRAFO, DUO can be made both of solid MDF board or cell board which results in the weight of a door wing. However it does not affect quality and endurance of the product.

REBATED DOOR WING IN CZECH NORM

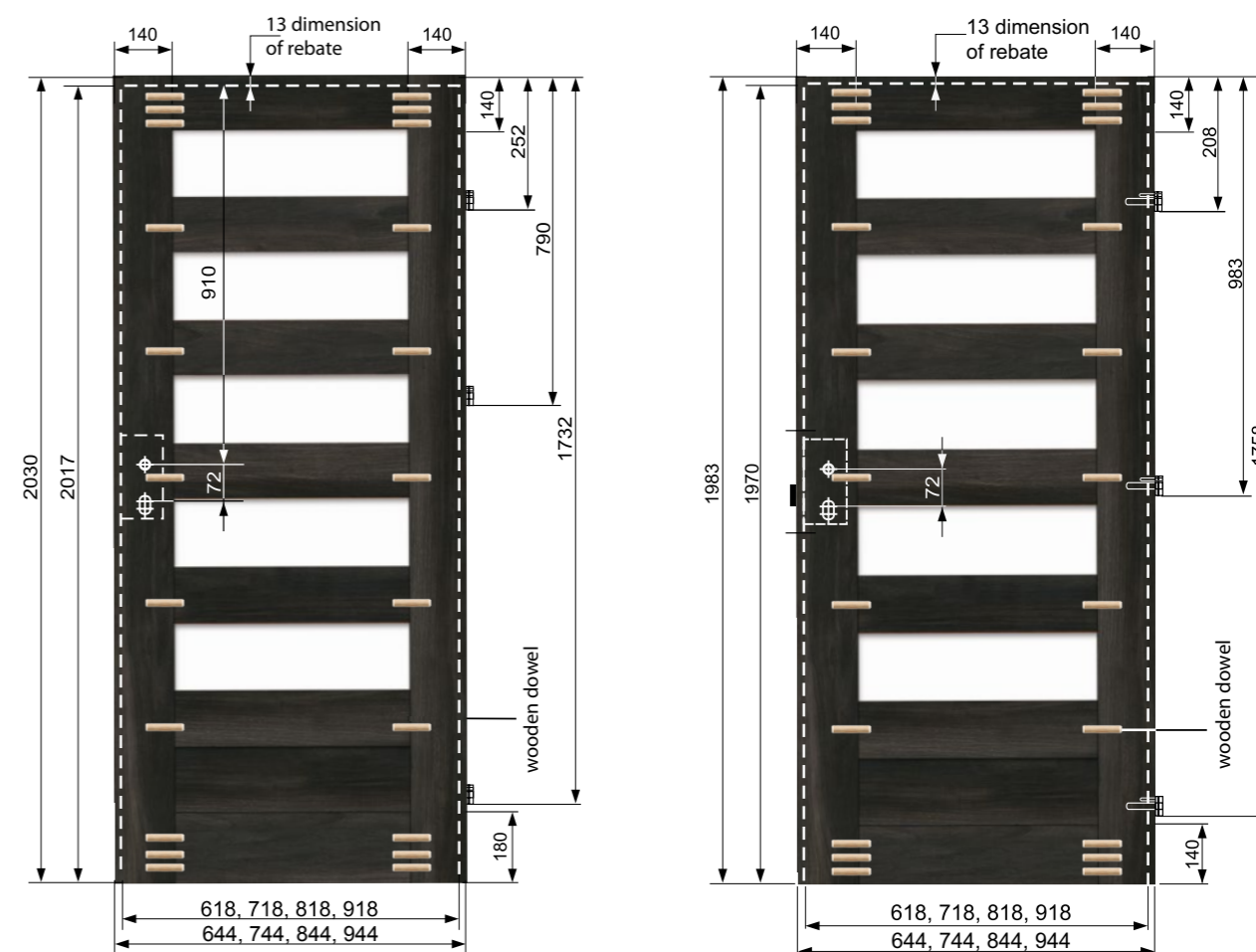

SINGLE NON-REBATED DOOR WINGS

- Standard width of door wings: 60, 70, 80, 90.
- Width 100 – non-rebated framed door wings: additional charge. Does not feature wings: MEDIOLAN and LOFT.
- Width 100 – panel door wing additional charge
- Due to the fact that the decorative foil with which our products are glued imitates the grain of the wood, which does not have the same grain pattern and the same colour throughout the length and width of the tree, the decorative foil in the longitudinal and transverse direction does not have the same colours and grains.
- Between ABS rim and the wing surface a slight difference in colour and structure might appear.

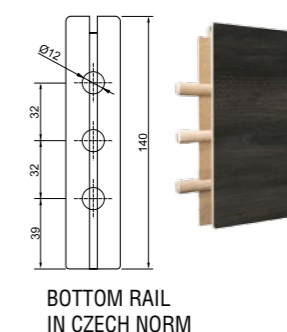
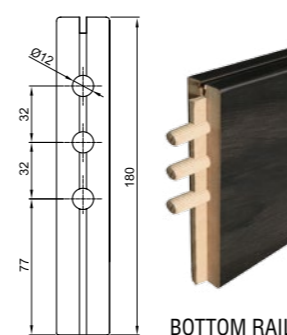
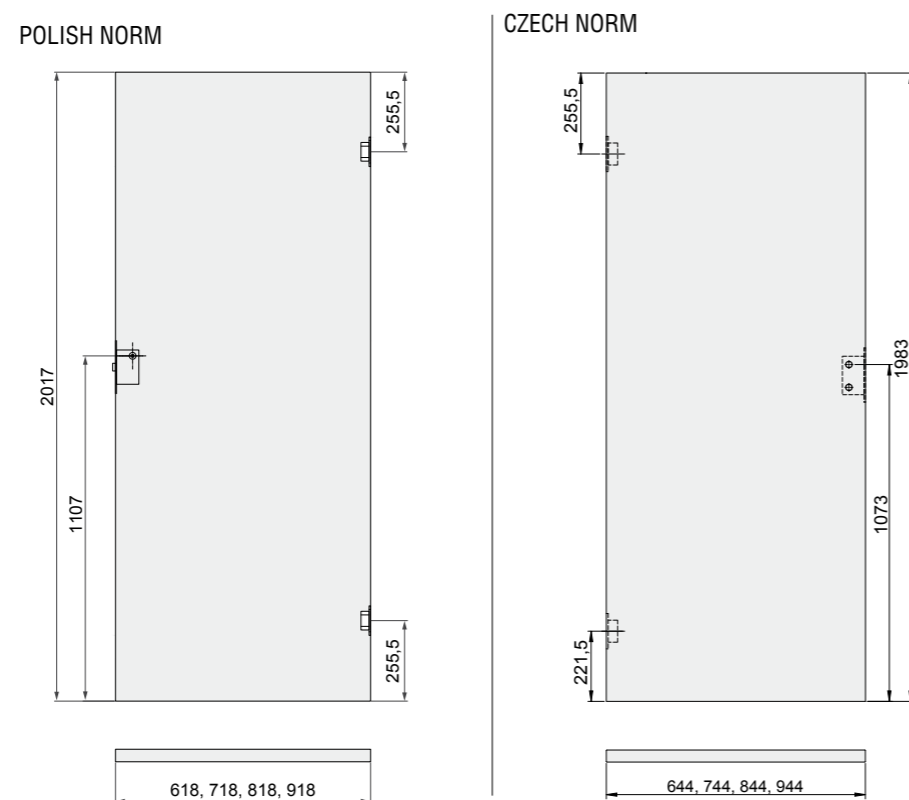

Height of bottom rail in Czech norm: door wing DUO: 359 mm (406 mm PL), rebated door wing MOBI: 342 mm (389 mm pl), door wings: VINCI, BELLO, MEDIOLAN, BORNOS: 133 mm (180 mm pl). Non-rebated door wings in Czech norm – bottom rail with cut 47 mm. Door wings: LOFT, KUBUS, MONO, WINDOOR (IV, SPHAGETTI), PLATO – not available in Czech norm.

FRAMED DOOR WINGS



VENTILATION SOLUTIONS



Grilled PVC ventilation sleeve – Ø 47 mm.
Brass ventilation sleeve – Ø 40 mm.



VENTILATION CUT OF DOOR WING MODERNO



NON-REBATED SLIDING DOOR WING

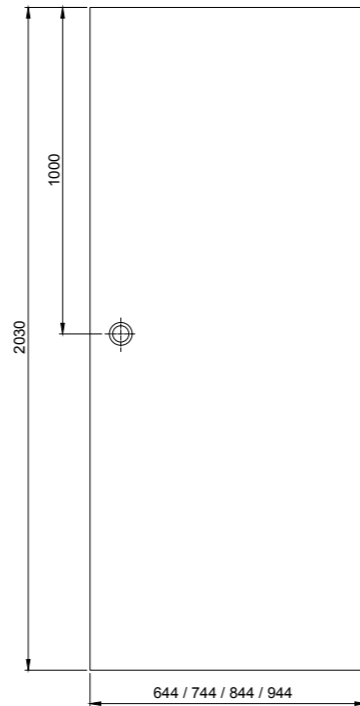

sliding door wings
– veneering rails 360°



Options of door wing stabilising filling



Construction of panel door wing

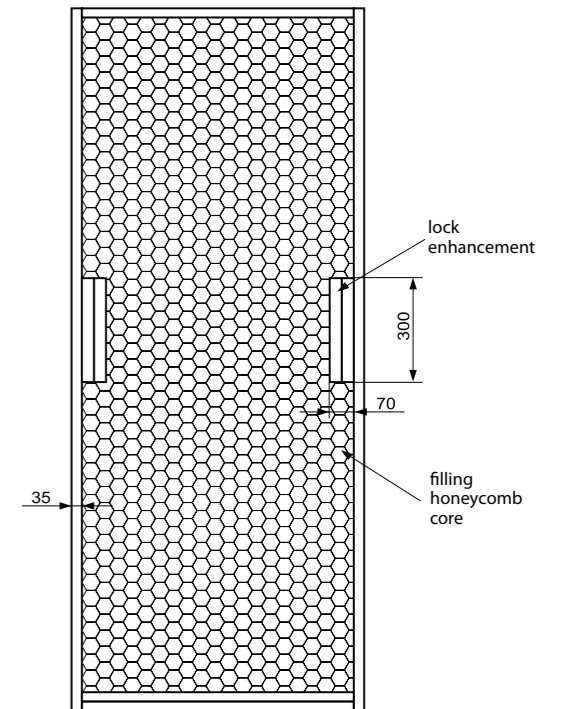

DOUBLE DOORS



DOUBLE DOORS

Rebated double door wings

Dimension symbol	Dimensions [mm]		
	SZ	SW	Configuration: active wing (A) + passive (B)
100D	1078	1052	744+344*, 644+444
110D	1178	1152	844+344*, 744+444, 644+544
120	1278	1252	944+344*, 844+444, 744+544, 644+644
130	1678	1352	1044+344*, 944+444, 844+544, 744+644, 644+744
140	1478	1452	1044+444, 944+544, 844+644, 744+744, 644+844
150	1578	1552	1044+544, 944+644, 844+744, 744+844, 644+944
160	1678	1652	1044+644, 944+744, 844+844, 744+944, 644+1044
170	1778	1752	1044+744, 944+844, 844+944, 744+1044
180	1878	1852	1044+844, 944+944, 844+1044
190	1978	1952	1044+944, 944+1044
200	2078	2052	1044+1044

*dimension 30 (344) only for full plain door wings



DOUBLE DOOR WINGS = WING PRICE x 2 + ADDITIONAL CHARGE

Framed door wings of width 40, 50 do not feature tempered glass. There may appear a colour difference in the glass.

Panel door wing width 30, 40, 50 available without glazing.

Collection of framed door wings: Incanto, Prado, Mediolan, Bello, Bornos, Kubus, Rocco, Tango are not available in width 40, 50.

Rebated double doors – fixed door frame

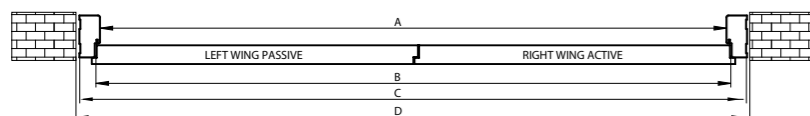

	dimensions (mm)			
	A	B	C	D
100D	1036	1058	1124	1148
110D	1136	1258	1224	1248
120	1236	1358	1324	1348
130	1336	1458	1424	1448
140	1436	1558	1524	1548
150	1536	1658	1624	1648
160	1636	1758	1724	1748
170	1736	1858	1824	1848
180	1836	1958	1924	1948
190	1936	2058	2024	2048
200	2036	2158	2124	2148

Rebated double doors – adjustable standard door frame

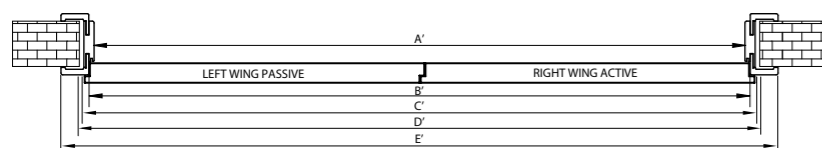

	dimensions (mm)					
	A'	B'	C'	D'	E' (for 60)	E' (for 80)
100D	1036	1058	1080	1110	1178	1218
110D	1136	1258	1180	1210	1278	1318
120	1236	1358	1280	1310	1378	1418
130	1336	1458	1380	1410	1478	1518
140	1436	1558	1480	1510	1578	1618
150	1536	1658	1580	1610	1678	1718
160	1636	1758	1680	1710	1778	1818
170	1736	1858	1780	1810	1878	1918
180	1836	1958	1880	1910	1978	2018
190	1936	2058	1980	2010	2078	2118
200	2036	2158	2080	2110	2178	2218

DOUBLE DOORS

Non-rebated double door wings

Dimension symbol	Dimensions [mm]	
	SZ	Configuration: active wing (A) + passive (B)
100D	1078	744+344*, 644+444
110 D	1178	844+344*, 744+444, 644+544
120	1278	944+344*, 844+444, 744+544, 644+644
130	1378	1044+344*, 944+444, 844+544, 744+644, 644+744
140	1478	1044+444, 944+544, 844+644, 744+744, 644+844
150	1578	1044+544, 944+644, 844+744, 744+844, 644+944
160	1678	1044+644, 944+744, 844+844, 744+944, 644+1044
170	1778	1044+744, 944+844, 844+944, 744+1044
180	1878	1044+844, 944+944, 844+1044
190	1978	1044+944, 944+1044
200	2078	1044+1044

*dimension 30 (344) only for full plain door wings



DOUBLE DOOR WINGS = WING PRICE x 2 + ADDITIONAL CHARGE

Framed door wings of width 40, 50 do not feature tempered glass.

There may appear a colour difference in the glass.

Door wing MEDIOLAN is not available in width 40 and 50.

LOFT and MAGNETIC COLLECTIONS do not feature double-doors version.

Non-rebated double door wings – fixed door frame V-retto

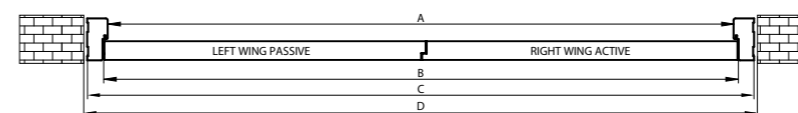

Dimension symbol	dimensions [mm]			
	A	B	C	D
100D	1062	1084	1150	1174
110 D	1162	1184	1250	1274
120	1262	1284	1350	1374
130	1362	1384	1450	1474
140	1462	1484	1550	1574
150	1562	1584	1650	1674
160	1662	1684	1750	1774
170	1762	1784	1850	1874
180	1862	1884	1950	1974
190	1962	1984	2050	2074
200	2062	2084	2150	2174

Non-rebated double door wings – adjustable door frame V-retto

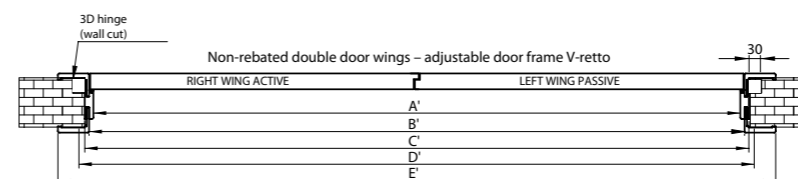

Dimension symbol	dimensions [mm]				
	A'	B'	C'	D'	E'
100D	1062	1084	1106	1136	1244
110D	1162	1184	1206	1236	1344
120	1262	1284	1306	1336	1444
130	1362	1384	1406	1436	1544
140	1462	1484	1506	1536	1644
150	1562	1584	1606	1636	1744
160	1662	1684	1706	1736	1844
170	1762	1784	1806	1836	1944
180	1862	1884	1906	1936	2044
190	1962	1984	2006	2036	2144
200	2062	2084	2106	2136	2244

ADJUSTABLE TUNNEL DOOR FRAME V-RETTO



ADJUSTABLE TUNNEL DOOR FRAME



DIMENSIONS (MM)

DOOR FRAME WIDTH	A	B	C	D	E	F	G	H
60	602	624	686	784	2018 PL 1971 CZ	2029 PL 1982 CZ	2109 PL 2062 CZ	2060 PL 2013 CZ
70	702	724	786	884				
80	802	824	886	984				
90	902	924	986	1084				
100	1002	1024	1086	1184				
105	1052	1074	1136	1234				
110	1102	1124	1186	1284				
115	1152	1174	1236	1334				
120	1202	1224	1286	1384				
125	1252	1274	1336	1434				
130	1302	1324	1386	1484				
135	1352	1374	1436	1534				
140	1402	1424	1486	1584				
145	1452	1474	1536	1634				
150	1502	1524	1586	1684				
155	1552	1574	1636	1734				
160	1602	1624	1686	1784				
165	1652	1674	1736	1834				
170	1702	1724	1786	1884				
175	1752	1774	1836	1934				
180	1802	1824	1886	1984				
185	1852	1874	1936	2034				
190	1902	1924	1986	2084				
195	1952	1974	2036	2134				
200	2002	2024	2086	2184				

DIMENSIONS (MM)

DOOR FRAME WIDTH	A	B	C	D1 (MASKING BAND 60)	D2 (MASKING BAND 80)	E	F	G1 (MASKING BAND 60)	G2 (MASKING BAND 80)	H
60	602	624	686	744	784	2018 PL 1971 CZ	2029 PL 1982 CZ	2089 PL 2042 CZ	2109 PL 2062 CZ	2060 PL 2013 CZ
70	702	724	786	844	884					
80	802	824	886	944	984					
90	902	924	986	1044	1084					
100	1002	1024	1086	1144	1184					
105	1052	1074	1136	1194	1234					
110	1102	1124	1186	1244	1284					
115	1152	1174	1236	1294	1334					
120	1202	1224	1286	1344	1384					
125	1252	1274	1336	1394	1434					
130	1302	1324	1386	1444	1484					
135	1352	1374	1436	1494	1534					
140	1402	1424	1486	1544	1584					
145	1452	1474	1536	1594	1634					
150	1502	1524	1586	1644	1684					
155	1552	1574	1636	1694	1734					
160	1602	1624	1686	1744	1784					
165	1652	1674	1736	1794	1834					
170	1702	1724	1786	1844	1884					
175	1752	1774	1836	1894	1934					
180	1802	1824	1886	1944	1984					
185	1852	1874	1936	1994	2034					
190	1902	1924	1986	2044	2084					
195	1952	1974	2036	2094	2134					
200	2002	2024	2086	2144	2184					

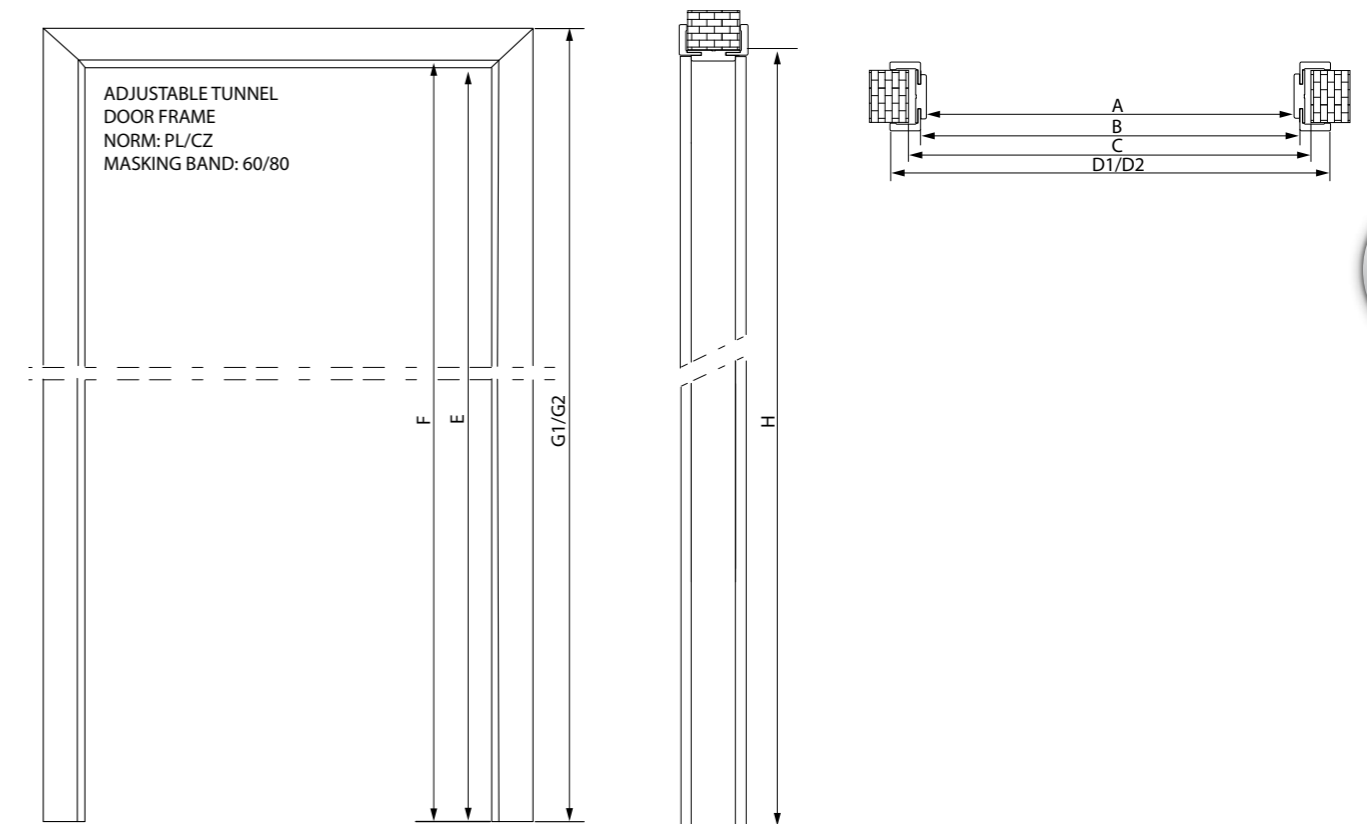
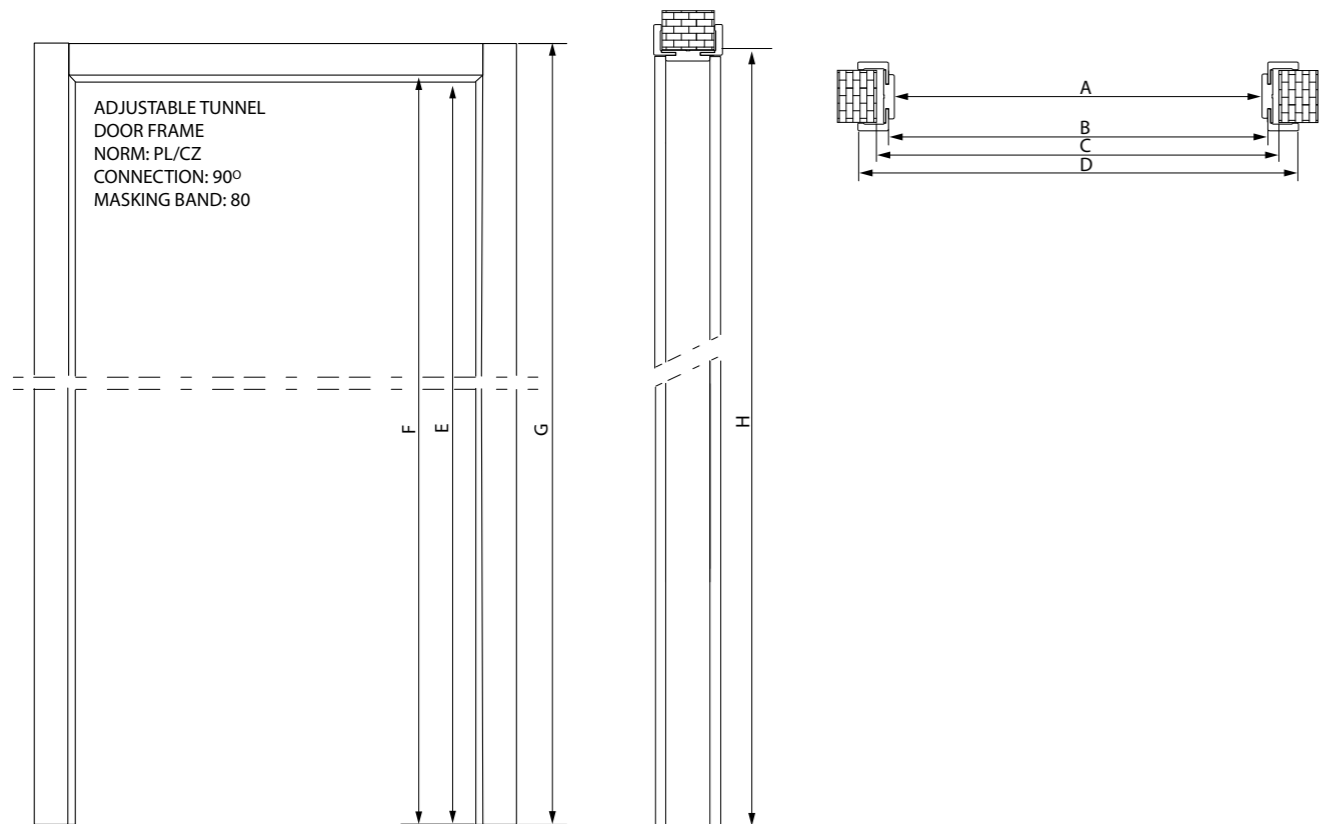

FIXED TUNNEL DOOR FRAME



CASING FRAME TUNNEL DOOR FRAME



DIMENSIONS (MM)

DOOR FRAME WIDTH	A	B	C	D	E	F
60	602	690	714	2018 PL 1971 CZ	2062 PL 2016 CZ	2074 PL 2028 CZ
70	702	790	814			
80	802	890	914			
90	902	990	1014			
100	1002	1090	1114			
105	1052	1140	1164			
110	1102	1190	1214			
115	1152	1240	1264			
120	1202	1290	1314			
125	1252	1340	1364			
130	1302	1390	1414			
135	1352	1440	1464			
140	1402	1490	1514			
145	1452	1540	1564			
150	1502	1590	1614			
155	1552	1640	1664			
160	1602	1690	1714			
165	1652	1740	1764			
170	1702	1790	1814			
175	1752	1840	1864			
180	1802	1890	1914			
185	1852	1940	1964			
190	1902	1990	2014			
195	1952	2040	2064			
200	2002	2090	2114			

DIMENSIONS (MM)

DOOR FRAME WIDTH	A	B	C	D (MASKING BAND 80)	E	F	G2 (MASKING BAND 80)	H
60	548	570	598	730	1991 PL 1944 CZ	2002 PL 1955 CZ	2082 PL 2035 CZ	2018 PL 1971 CZ
70	648	670	698	830				
80	748	770	798	930				
90	848	870	898	1030				
100	948	970	998	1130				
105	-	-	-	-				
110	1048	1070	1098	1230				
115	-	-	-	-				
120	1148	1170	1198	1330				
125	-	-	-	-				
130	1248	1270	1298	1430				
135	-	-	-	-				
140	1348	1370	1398	1530				
145	-	-	-	-				
150	1448	1470	1498	1630				
155	-	-	-	-				
160	1548	1570	1598	1730				
165	-	-	-	-				
170	1648	1670	1698	1830				
175	-	-	-	-				
180	1748	1770	1798	1930				
185	-	-	-	-				
190	1848	1870	1898	2030				
195	-	-	-	-				
200	1948	1970	1998	2130				

170

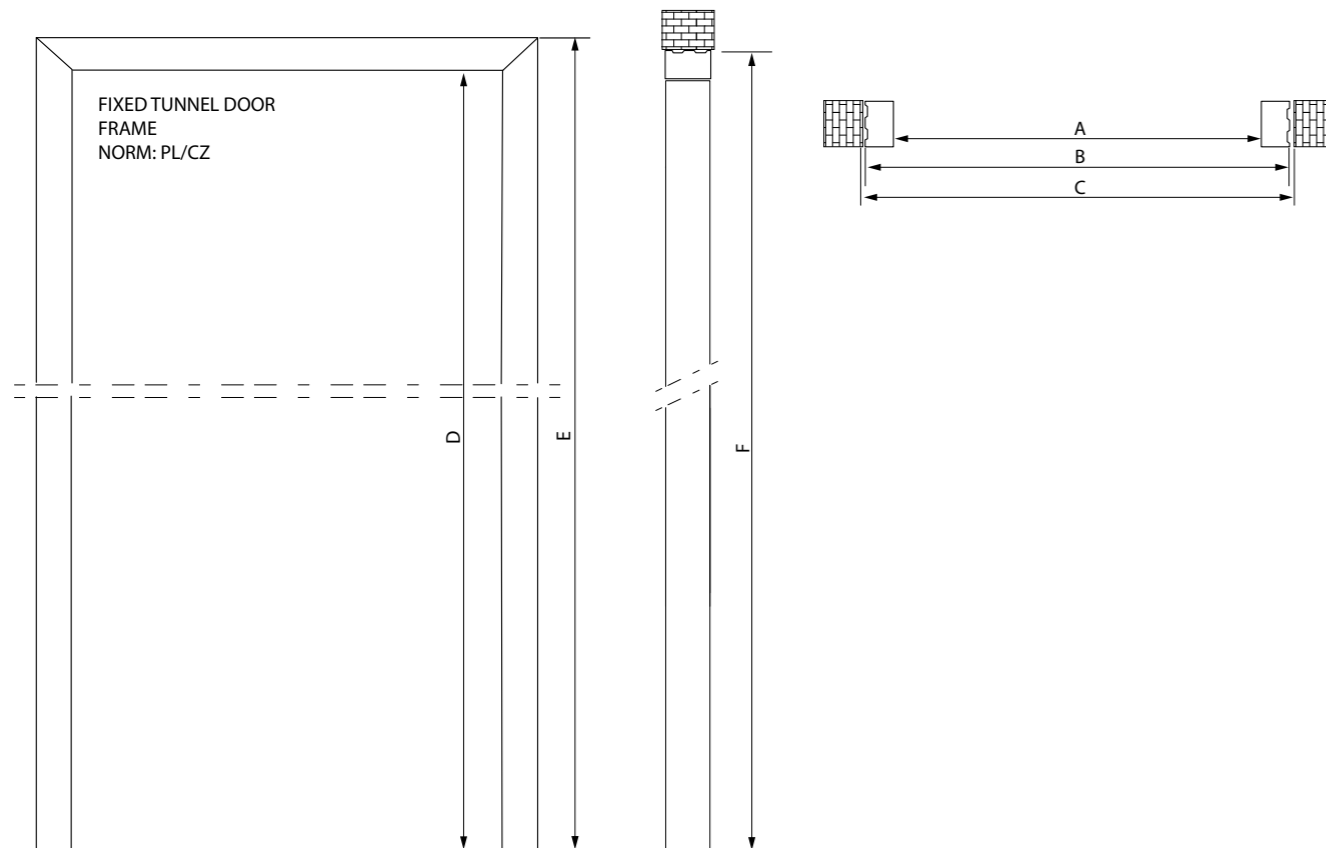

171

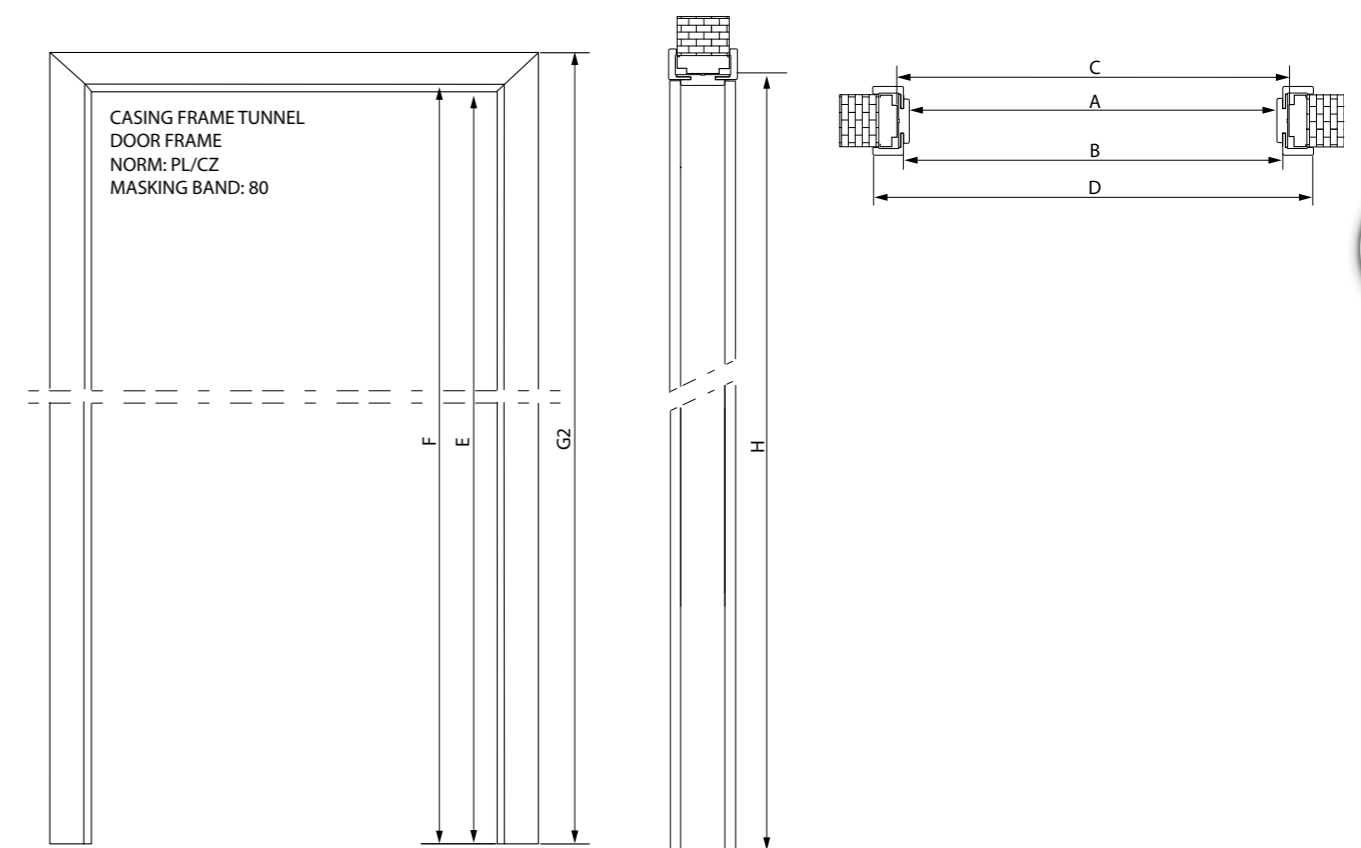

VOSTER DOORS



MAGNETIC S
non-rebated door wing
with magnetic lock
page 116-117



FULL PLAIN DOOR WING
with door frame **SARA PRO**
– hidden system
page 110-111



TOPS
page 148-149



MAGNETIC
non-rebated door wing
with magnetic
lock and long holder
page 116-117

VOSTER DOORS

**OPENWORK DECORATIVE
PANELS**
to sliding plain door wings.
page 150



**DECORATIVE PROFILES:
LAMELLAS**
page 154-155



174



MAGPLUS
sliding door wing
page 138-139



175

MODERNO
non-rebated door wing
page 114-115

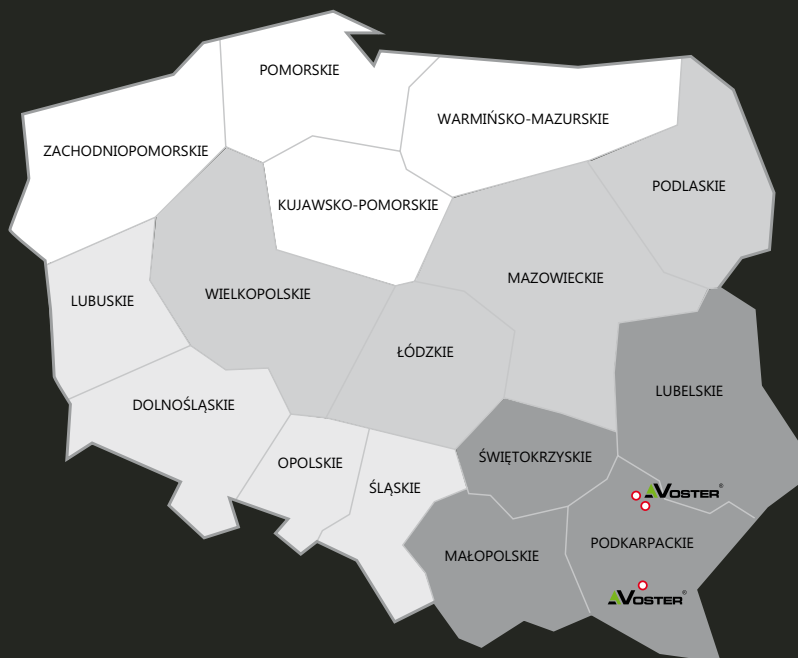

SALES REPRESENTATIVES

+48 609 482 500



www.voster.pl



Check where You can buy our products

The visualisations included in the catalogue show door wing width 80. In case of other widths of door wings, the glazing, glazing profiles will be different. The presented photos and decors may differ in colour from the original products. Please read assembly instruction and guarantee terms and condition before starting any works. Voster Company has the right to modify the offer included in the catalogue without prior notice.



Zarzecze, ul. Mickiewicza 155, 37-400 Nisko

tel. +48 15 870 14 44, +48 15 841 11 94, fax +48 15 870 14 85

e-mail: handlowy@voster.pl www.voster.pl



WWW.FACEBOOK.COM/VOSTER.DRZWI/



INSTAGRAM

WWW.INSTAGRAM.COM/VOSTER_DRZWI/